



United Technologies

Airovision

Air Handling Unit

39 HQ



The Difference Is In The Detail...



Alarko Carrier

Established in 1954 and operating in the fields of heating, cooling, ventilation, water treatment and pressurization, Alarko Sanayi ve Ticaret A. Ş. entered into a partnership at an equal rate with world leading organization Carrier in 1998 and company name was changed as Alarko Carrier Sanayi ve Ticaret A. Ş.

Alarko Carrier San. Tic. A. Ş. with core business in air-conditioning, has been maintaining operations since 2001 at manufacturing plants having a closed area of 36.800 m² on a land of 60.500 m² located within Gebze Organized Industrial Zone. At Alarko Carrier main manufacturing plant holding ISO 9001, ISO 14001, ISO 18001, ISO 50001 and SA 8000 certification, air handling units and rooftops are manufactured under Carrier brand and boilers, burners, submersible and circulating pumps and water boosters are manufactured under Alarko brand; panel radiators are manufactured at Ra-

diator Production Plant having a closed area of 9.250 m² and 18.000 m² open area at Dudulu Organized Industrial Zone.

A total of 609 people; 169 engineers, 216 white collar personnel and 224 workers are employed at Alarko Carrier manufacturing plants and Ankara, İzmir, Adana and Antalya offices.

Alarko Carrier develops products with competition and improvement possibilities by means of R&D activities, manufactures with modern technology and lean manufacturing methods and supplies complementary products and addresses the market. Alarko Carrier conveys products of many international manufacturers to consumers as an agent or partner.

Alarko Carrier who offers manufacturing, sales, export and service as integrated exports products manufactured to many countries all over the world.

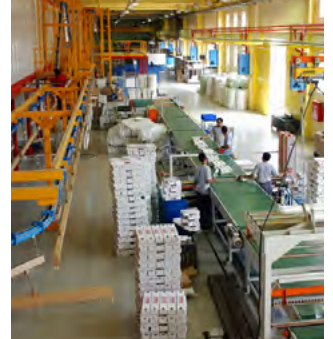

Extensive authorized service and sales network throughout Turkey





Carrier was among the first companies to set energy reduction goals for our factories in 1988. This led to our first company-wide global environmental, health and safety goals in 1997.

From 2000 to 2011
Carrier factories

reduced water usage

by

27%

From 2000 to 2011
Carrier factories

reduced air emissions

by

60%

From 2006 to 2011
Carrier has lowered

greenhouse gas emissions

by

35%

Carrier implemented a new machine tool lubrication process that reduced volatile organic compound emissions by more than **80%** below the baseline.





1. Standards	6
1.1 EN 1886 - 2007: Air Handling Units – Mechanical Performance	7
1.1.1 Mechanical Strength.....	7
1.1.2 Casing Air Leakage.....	8
1.1.3 Filter Bypass Leakage	8
1.1.4 Thermal Transmission.....	8
1.1.5 Thermal Bridging	9
1.1.6 Acoustic Casing Insulation	9
1.2 Eurovent Energy Class Calculation Method in Air Handling Units – 2013 ...	9
<hr/>	
2. Selection Software	11
2.1 Airovision Builder	12
2.2 Airovision Builder Selection Software Interface	12
2.3 3-D Unit Image Preview.....	12
2.4 Unit Drawings in Pdf or Dwg (Autocad) Format	13
2.5 Selection Report Fan Curves	13
2.6 Selection Report Psychrometric Diagram Curves	13
<hr/>	
3. Dimensions	14
<hr/>	
4. Casing	16
4.1 Profile	18
4.2 Corners	19
4.3 Base Frame	19
4.4 Panels.....	20
4.5 Insulation.....	21
4.6 Screws	22
4.7 Sealing Strips.....	22
4.8 Connection Supports.....	23
4.9 Doors	23
<hr/>	
5. Exterior Installation	26
<hr/>	
6. Inlet / Outlet / Mixing Cell and Dampers	28
<hr/>	
7. Filters	31
<hr/>	
8. Heat Recovery Systems	35
8.1. Wheel Type Heat Recovery Systems.....	36
8.2. Plate Type Heat Recovery Systems.....	39
8.3. Round Around Coil Type Heat Recovery Systems	40
8.4 Heat Pipe Type Heat Recovery Systems	40
8.4.1. Horizontal/Vertical Heat Pipe Type Heat Recovery.....	41
8.4.2. Horse Shoe Heat Pipe Type Heat Recovery.....	41
<hr/>	
9. Coils	42
<hr/>	

10. Electric Heater	47
<hr/>	
11. Humidifiers	49
<hr/>	
12. Fans	52
<hr/>	
13. Diffuser	57
<hr/>	
14. Silencer	58
<hr/>	
15. UVC Lamp	59
<hr/>	
16. Other Accessories	60
<hr/>	
17. Control	64
17.1 Control Panel	66
17.1.1 External Panel	66
17.1.2 Internal Control Panel	67
17.2 Controller	68
17.3 HMI.....	68
17.4 Options.....	69
17.5 Field Equipments	69
17.6 Scenarios.....	69
<hr/>	
18. Special Applications	70
<hr/>	
19. Hygienic Air Handling Unit	73
19.1 Panels	76
19.2 Coils	77
19.3 Silencer	77
19.4 Fans.....	78
19.5 Heat Recovery Systems	79
19.6 Filters	80
19.7 Humidifiers	80
19.8 Service and Maintenance	81
<hr/>	
20. Certificates	82
<hr/>	
21. Tests	84
<hr/>	
22. References	86
<hr/>	
23. Specifications	102
<hr/>	





1 Standards

December 2008

THE NORM

DIN

946-4

Supersedes
DIN 1946-4:1999-03 and
DIN 4799:1990-06

ing –
ings and rooms used in the health care

In Gebäuden und Räumen des Gesundheitswesens

TS EN 1886
Nisan 2009

ICS 91.140.30

DARDI
DARD

6+A1:2011(EN)
Ocak 2012

ICS 91.140.30

(A) İŞLEME
MANSI
Mechanical

HAVA TAŞIMA
BÖLÜMLERİN
ORANLARI
- Rating and

Document comprises 68 pages

Translation by DIN-Sprachendienst.
In case of doubt, the German-language original should be consulted as the authoritative text.

English price group 23
www.din.de
www.beuth.de



Information may be reproduced without prior permission of
Institut für Normung e.V., Berlin, Beuth Verlag GmbH, 10772 Berlin, Germany.
Right of sale for German Standards (DIN-Normen).

velocity and heat

aynı olup,
Brussels)

ullanım
TSE

pressure drop is
the heat
taken into
ethylene
electric
fence
floor

Units with
- classes
as defined, given
rior to for

(1)

(2)

(3)

(4)

1. STANDARDS

Essential standards applied in Europe for air handling units are specified below:

- **EN 1886: 2007**
Ventilation for Buildings – Air Handling Units – Mechanical Performance
- **EN 13053: 2006 + A1: 2011**
Air Handling Units – Ratings and performance for units, components and sections
- **EN 13779:**
Ventilation for Non-Residential Buildings - Performance Requirements for Ventilation and Room-Conditioning Systems
- **DIN 1946/4 - 2008:**
Ventilation and Air Conditioning – Part 4: VAC Systems in Buildings and Rooms Used in the Health Care Sector

1.1 EN 1886 - 2007: Air Handling Units – Mechanical Performance

The characteristics of the casing wall construction of the air handling unit must be established in accordance with EN 1886, based on measurements carried out on a model box and a real unit.

A model box is an air handling unit without its installed components that consists of two sections with a joint. Each section also has a door. The dimensions and the construction must comply with the requirements of the standard.

Thermal and acoustic characteristics of a casing wall construction are exclusively determined on the basis of measurements taken on the model box, while mechanical strength, air leakage and filter bypass leakage must be determined on the basis of measurements taken on a real unit, that has been designed for an HVAC application.

Specifications as per EN 1886 – 2007

Specifications (EN 1886)						
Thermal Transmission	T5	T4	T3	T2	T1	
Thermal Bridging	TB5	TB4	TB3	TB2	TB1	
Filter Bypass Leakage	G1-G4	F5	F6	F7	F8	F9
Body Sealing	L3	L2	L1			
Mechanical Strength	D3	D2	D1			

In the table, the class the standard construction model box GP080* complies with is marked in blue ■.

1.1.1 Mechanical Strength

There are two test criteria for mechanical strength:

- Relative deflection [mm x m⁻¹] of posts and panels under normal design conditions
- Mechanical resistance [no permanent deformation] against maximum fan pressure

When testing the mechanical strength of the model box, the following test pressures apply:

- Deflection** • **1,000 Pa over and under-pressure in accordance with EN 1886**
Fan pressure • **2,500 Pa over and under-pressure in accordance with EN 1886**

The standard differentiates between the following classes:

Mechanical strength classes as per EN 1886 – 2007			
Body class 2007	Maximum relative deflection mm x m ⁻¹	Maximum strength against fan pressure	Quality
D1	4	Yes	+
D2	10	Yes	↑
D3	N/A	Yes	-

In the table, the class the standard construction model box GP080* complies with is marked in blue ■.

* See. Chapter 4 "Casing".

1.1.2 Casing Air Leakage

Depending on the construction of the air handling unit and the nominal operating pressures air leakage is measured at the following test conditions:

- All sections at 400 Pa negative pressure, if there is only negative pressure in the unit
- Positive pressure sections at 700 Pa or higher positive pressure, if the operating pressure after the fan is higher than 250 Pa. If the operating pressure that occurs is higher than 700 Pa, the positive pressure sections are tested under actual pressure conditions. The permissible air leakage is linked to the filter class in the relevant casing section. The table below lists the air leakage classes together with the associated filter classes.

The remaining sections are tested at 400 Pa negative pressure.

Casing leakage class as per EN 1886 – 2007				
Leakage class 2007	at -400 Pa maximum leakage $l \times s^{-1} \times m^{-2}$	at +700 Pa maximum leakage $l \times s^{-1} \times m^{-2}$	as per EN779 maximum filter class	Quality
L1	0.15	0.22	better than F9	+
L2	0.44	0.63	F8-F9	↑
L3	1.32	1.90	G1-F7	-

In the table, the class the standard construction model box GP080* complies with is marked in blue .

1.1.3 Filter Bypass Leakage

Filter bypass leakage refers to the total amount of unfiltered air after the filter section. The unfiltered air flow is the sum of:

- Air that passes the filter medium outside the filter section
- Air leakage through the walls of the sections after the filter, with negative pressure

Bypass leakage through the filter section is measured at a pressure difference of 400 Pa over the filter section, and filters are sometimes replaced by dummy plates with an air tightness mechanism identical to the one of the filters.

The table below lists the total admissible bypass leakage k in % of the design air flow over the filters as a function of the built-in filter class.

Maximum filter bypass leakage allowed as per EN 1886 - 2007					
Filter class	G1- F5	F6	F7	F8	F9
Total bypass leakage k %	6	4	2	1	0.5

The standard slide-in construction for filters, tested in a model box, is suitable for filter class F9.

In accordance with standard EN 1886, this is based on a face velocity of 2.5 m/s.

1.1.4 Thermal Transmission

The thermal transmission of a model box is the average heat transfer coefficient of the construction in $W \times m^{-2} \times K^{-1}$, referred to the external surface.

The measurement is carried out with heat sources in the model box, where the total power input and the average temperature difference between inside and outside is determined at a stable condition. Thermal transmission is the ratio between the total power input and the internal/external surface temperatures times their surface area. Depending on the measured values the construction has in one of the following classes:

Thermal transmission as per EN 1886 – 2007		
Class	Heat transfer coefficient $[W \times m^{-2} \times K^{-1}]$	Quality
T1	$U < 0.5$	+
T2	$0.5 < U < 1.0$	↑
T3	$1.0 < U < 1.4$	↑
T4	$1.4 < U < 2.0$	↑
T5	N/A	-

The standard construction GP080* complies with class T2, and it is marked in blue in the table.

1.1.5 Thermal Bridging

The thermal bridging factor of a model box is measured for the same set-up that is used to determine the heat transfer coefficient. At the stable condition the highest detectable surface temperature on the outside surface of the model box is measured. The thermal bridging factor is the quotient of indoor air temperature minus highest surface temperature and the air temperature difference between inside and outside.

The measured value is in one of the classes below and indicates if there is surface condensation or not. As the thermal bridging factor increases, the possibility of condensation decreases.

Thermal bridging factor as per EN 1886 – 2007		
Class	Thermal bridging factor [k _b]	Quality
TB1	0.75 < k _b < 1.0	+
TB2	0.60 < k _b < 0.75	
TB3	0.45 < k _b < 0.60	↑
TB4	0.30 < k _b < 0.45	
TB5	N/A	-

The standard construction GP080* complies with class TB2, and it is marked in blue  in the table.

1.1.6 Acoustic Casing Insulation

Acoustic casing insulation, as defined by EN 1886, is the attenuation achieved by enclosing a noise source with a model box. For this purpose the average sound pressure level of a noise source placed on the floor, is measured in an imaginary enclosing area. The measurement is repeated in the same enclosing area, but with the noise source in the model box.

The difference in the measured sound pressure levels, divided into octave bands of 125 to 8000 Hz, is the attenuation of the casing wall construction, including the doors and joint.

For the standard casing wall construction GP080*, the measured attenuation is shown in the table below:

Acoustic casing insulation as per EN 1886 – 2007							
Average octave band frequency [Hz]	125	250	500	1,000	2,000	4,000	8,000
Sound absorption [dB]	19.0	19.0	2.00	22.0	21.0	29.0	36.0

1.2 Eurovent Energy Class Calculation Method in Air Handling Units – 2013

Energy supplied to the Air Handling Units (AHUs) may be divided in two main groups: thermal energy (for heating and cooling) and electrical energy (for fans). Different levels for thermal energy consumption for heating are covered by the consideration of the Heat Recovery System (HRS) efficiency. The climate dependency for the thermal energy consumption is considered and the difference in primary energy between thermal energy and electrical energy is taken into account to evaluate the impact of the pressure drops across the HRS. The thermal energy for cooling is not considered because it will have less impact (negligible for most of Europe). Regarding electrical energy for fans, the method only accounts for the impact of the unit size and efficiency of fan assembly. Other components (e.g. coils) are not individually covered (hence the total pressure increases for fans are not considered) because there is a huge variation in the use of components in different AHU applications. The major influencing factors; velocity, HRS pressure drop, overall static efficiency of the supply and/or the extract air fan and efficiency of the electric motor(s), will give a good estimation of the used energy for fans. The classification, however, can not be considered as a system energy label.



* See. Chapter 4 "Casing".

Air Handling Unit Subgroups

Three subgroups, with different label signs, are defined:

a. Units for full or partial outdoor air at design winter temperature $\leq 9^{\circ}\text{C}$.

- This subgroup comprises units connected to outdoor air with the design outdoor temperature, winter time $\leq 9^{\circ}\text{C}$. If the unit contains a mixing section; it will be treated within this group as long as the amount of recirculation air is less than 85%. If more recirculation is claimed, the calculation value for 85% shall be used in the applicable equation for pressure correction Δp_z . This subgroup will consider the velocity in the filter cross section, the HRS efficiency and pressure drop and the mains power consumption to the fan(s). The class signs are A to <E.

b. Recirculation units or units with design inlet temperatures always $> 9^{\circ}\text{C}$.

- This subgroup includes units with 100% recirculation air, units connected to outdoor air for which the design outdoor temperature during winter time $> 9^{\circ}\text{C}$ or units with (pre-conditioned) inlet temperature $> 9^{\circ}\text{C}$ emanating from a make-up air unit up-stream. This subgroup will only consider the cross section velocity of the filter section and mains power consumption to the fan(s). The class signs are A \leftrightarrow to <E \leftarrow .

c. Stand-alone extract air units

- Subgroup for pure extract air units (First reason to allocate an energy label to this kind of unit application is that they could include heat recovery. Another reason is that the design outdoor temperature has no relevance for such units). This subgroup will only consider the cross section velocity of the filter section and mains power consumption to the fan(s). The class signs are A \uparrow to <E \leftarrow .

Table for energy efficiency calculations				
Energy Class	All Units	Units for full or partial outdoor air at design winter temperature $\leq 9^{\circ}\text{C}$.		Fan efficiency grade <i>NG_{ref}</i> -class [-]
	Velocity V class [m/s]	Heat recovery system η class [%]	Δp class [Pa]	
A+ / A+ \leftrightarrow A+ \uparrow	1.4	83	250	64
A / A \leftrightarrow A \uparrow	1.6	78	230	62
B / B \leftrightarrow B \uparrow	1.8	73	210	60
C / C \leftrightarrow C \uparrow	2.0	68	190	57
D / D \leftrightarrow D \uparrow	2.2	63	170	52
E / E \leftrightarrow E \uparrow	Calculation is not required			Not required

$$f_{s\text{-Pref}} = \frac{P_{s\text{-sup}} + P_{s\text{-ext}}}{P_{\text{sup-ref}} + P_{\text{ext-ref}}}$$

Absorbed power factor; $f_{s\text{-Pref}}$

- $P_{s\text{-sup}}$ = active power supplied from the mains, including any motor control equipment, to selected supply air fan [kW]
- $P_{s\text{-ext}}$ = active power supplied from the mains, including any motor control equipment, to selected extract air fan [kW]
- $P_{\text{sup-ref}}$ = supply air fan reference power [kW]
- $P_{\text{ext-ref}}$ = extract air fan reference power [kW]

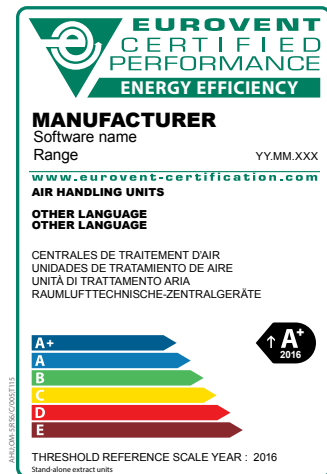
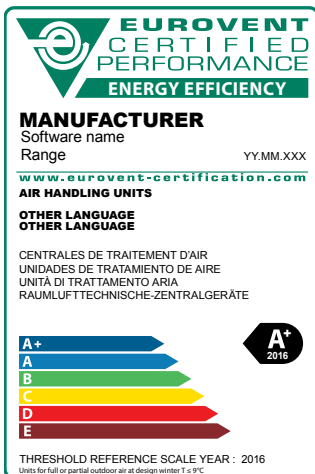



2 | Selection Software

2. SELECTION SOFTWARE

2.1 Airovision Builder

Carrier 39HQ Airovision air handling unit has a very flexible structure as per its design. This flexibility manifests itself both in dimensioning, as it consists of 160 mm imaginary modules, and in the use of any type of component inside it. It can meet any type of expectations of the customers in very different markets as it is exported to 65 different countries in 5 continents.

While selecting an air handling unit, the position and arrangement of components and each cell inside the air handling unit are very important both for reasons of cost and for ensuring the trouble-free operation of the device. Thus, the person making the selection shall pay great attention in the placement of each cell and component. Airovision Builder software provides great ease for the users in the placement of components inside the unit by allowing them to see the device and arrangement they have chosen with the 3 dimensional drawings of all components in the launch screen.

2.2 Airovision Builder Selection Software Interface

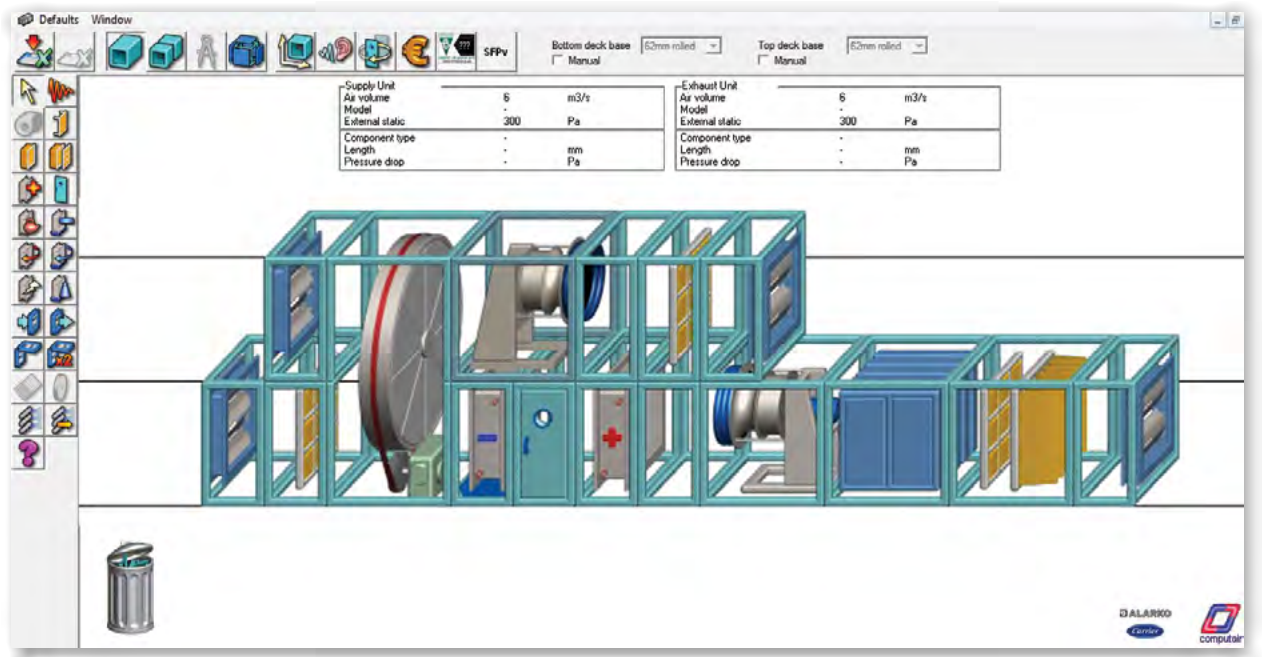

2.3 3-D Unit Image Preview

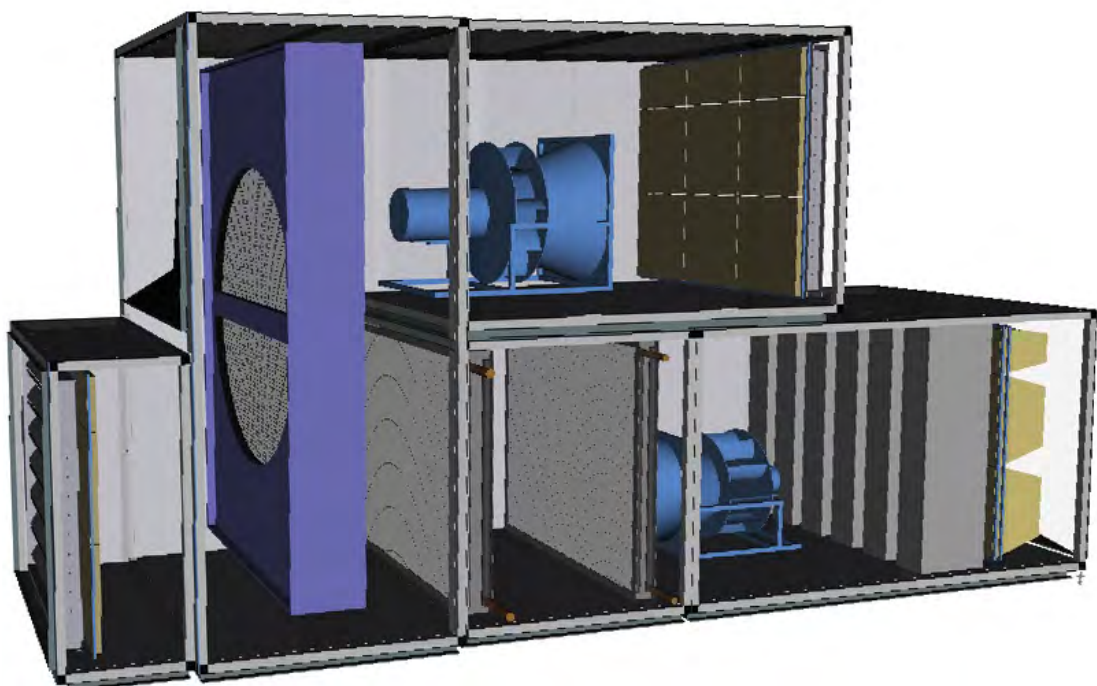

2.4 Unit Drawings in Pdf or Dwg (Autocad) Format

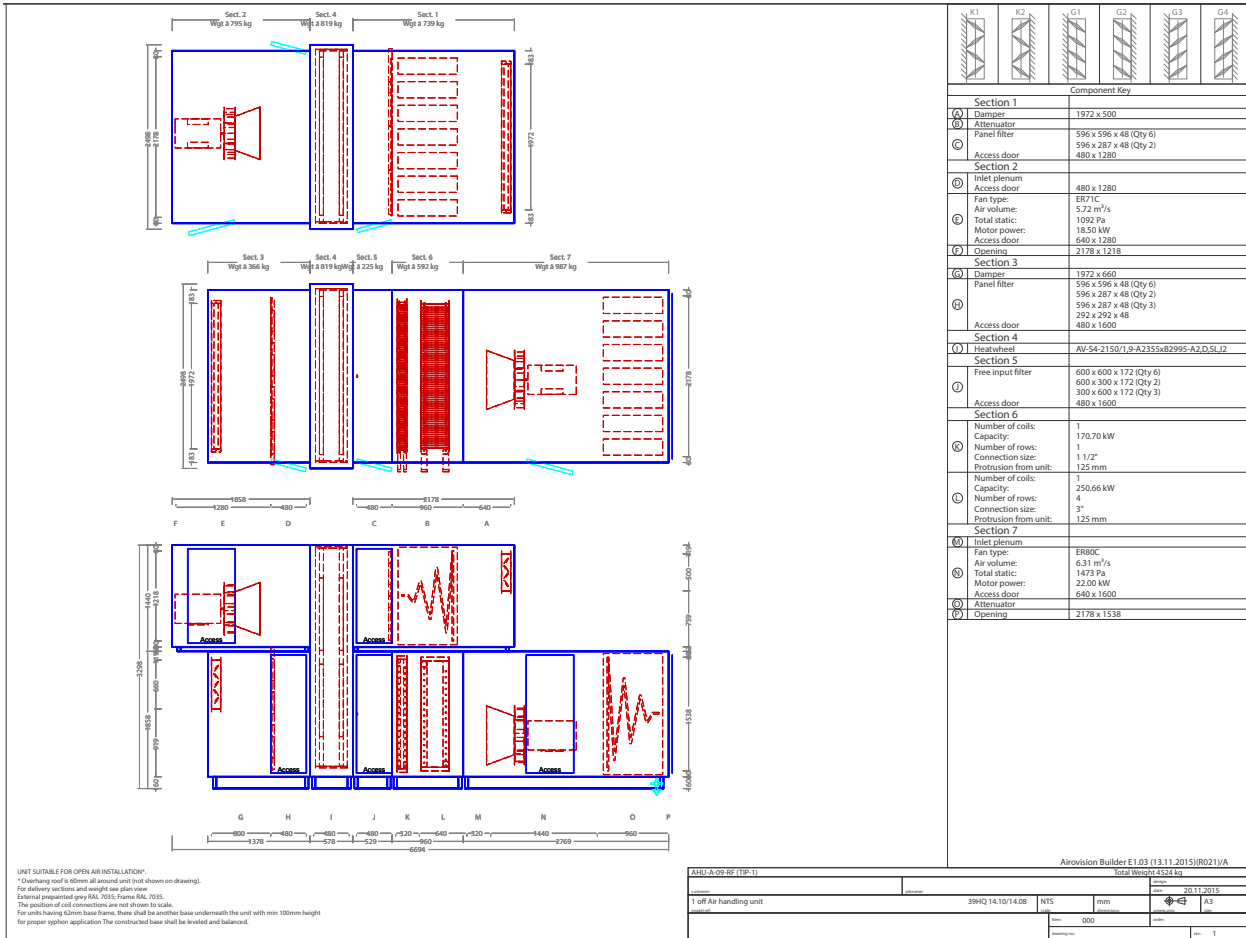

2.5 Selection Report Fan Curves

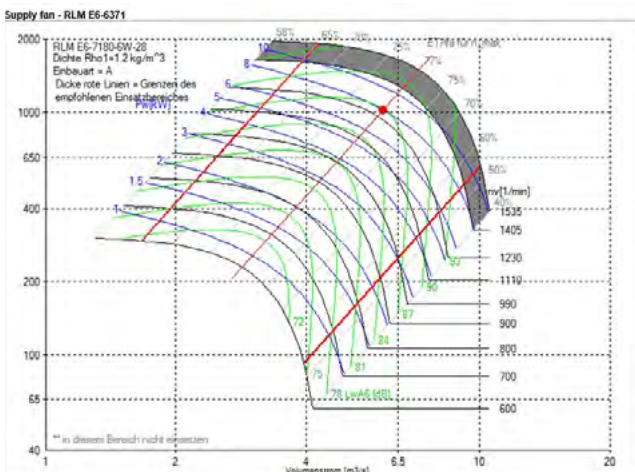



3 | Dimensions

Dimensions

3

3. DIMENSIONS

Module	Width																								
	4	5	6	7	8	9	10	11	12	13	14	15	16	17	18	19	20	21	22	23	24	25			
Elevation	2.5	3	3	4																					
	4	4	5	6	7	8	9	10	11	12															
	6	6	8	9	11	12	14	15	17	18	20	21	23	24	26	27									
	8			12	14	16	18	20	22	24	26	28	30	32	34	36	38	40	42	44	46	48			
	10					20	23	25	28	30	33	35	38	40	43	45	48	50	53	55	58	60	63		
	12						27	30	33	36	39	42	45	48	51	54	57	60	63	66	69	72	75		
	14										42	46	49	53	56	60	63	67	70	74	77	81	84	88	
	16											52	56	60	64	68	72	76	80	84	88	92	96	100	
	18			x 1,000 m³/h														81	86	90	95	99	104	108	113
	20																		100	105	110	115	120	125*	

*Note: Modules with larger sizes may be provided.

39HQ 14.12 ——— Height of Air Handling Unit (module)
 ——— Width of Air Handling Unit (module)

Module size: 160 mm
 External width: (n x module) + 98 mm
 External height: (n x module) + 98 mm
 Base frame height: 160 mm or 62 mm

Example: 39HQ12.10
 Width: (12 x 160) + 98 = 2018 mm
 Height: (10 x 160) + 98 = 1698 mm
 Nominal air flow rate: 8.5 m³/s (30x1000 m³/h)

- 39HQ series air handling units are composed of the combination of virtual modules with a width, height and length of 160 mm.
- They may be manufactured with a total of 122 different cross sections (width x height) for flow rates varying from 2,000 m³/h to 125,000 m³/h.
- Fully flexible production with installation to interior, exterior, vertical and concealed roof types and with any size desired is possible.

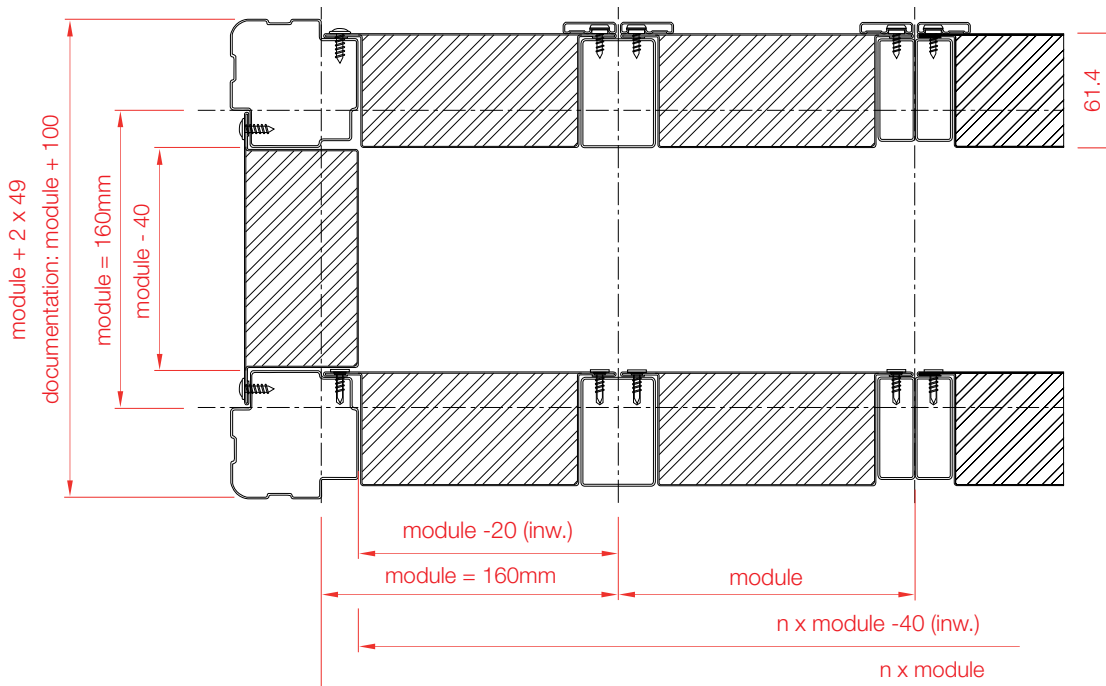



4 | Casing

4. BODY

The construction of the Carrier air handling units consists of a profile and panels. Profiled 1-mm thick casing sides of galvanised and coated steel plates ensure a rigid and lightweight frame. The profile holds a 60-mm dual-skin casing wall with panels, doors, inspection hatches and removable centre posts. The casing wall construction comes in several versions of steel plate thicknesses, material types and insulation materials used. The internal plating is always 0.8 mm thick. The standard casing wall construction GP080 consists of 0.8 mm internal and external plating with mineral wool (glass wool) in between.

The floor panel of the standard casing wall construction is made with isophenic (IPN) insulation for enhanced thermal characteristics and the possibility to walk on it. Compared with PUR, IPN insulation has an increased insulation value and improved fire resistance. Other advantages of IPN insulation are high pressure resistance and the possibility to walk on it.

As various markets have different requirements there are also versions with rock wool insulation and other panel thicknesses and plate materials, such as stainless steel. The RR125 acoustic version has an additional acoustic plate in the internal panel especially designed to efficiently dampen low-frequency sounds.

Coding	G	P	080	-
Digit	1	2	3	4

1: G = insulation, side and roof panels (G = glass wool, R = rock wool)

2: P = insulation, floor panel (P = IPN, R = rock wool)

3: 080 = thickness of the external plating (080 = 0.80 mm / 125 = 1.25 mm)

4: A = Acoustic version

Panels of 39HQ air handling units are designed for easy removal and installation. As the panel and profiles are made of galvanized steel, removal and installation of screws do not cause any kind of deformation on the panel or profile body. This is the main advantage of using galvanized steel profiles against air handling units with aluminium profiles. Because the deformation of the panel or the profile is one of the main elements that would endanger the sealing of the body.

Easily removable panels provides ease both during installation and maintenance and service in the field.

It provides benefits both in terms of hygiene and aesthetic by ensuring a smooth surface inside and outside the air handling units without using any additional components.

Fully removable panels



4.1 Profile

Profile is important for the air handling units so much as the skeleton is important for the human body. Polyester powder painted galvanized steel structure with a thickness of 1 mm is used in Carrier 39HQ air handling units.

Screw holes are pre-drilled in the supplier and painted afterwards.

Density of zinc coating 225 gr/m² (Z225)

Clamped profile structure.

Imported from Europe.

All side are painted both inside and outside

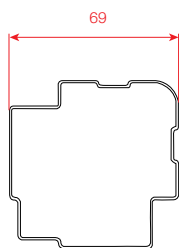
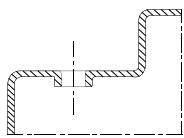
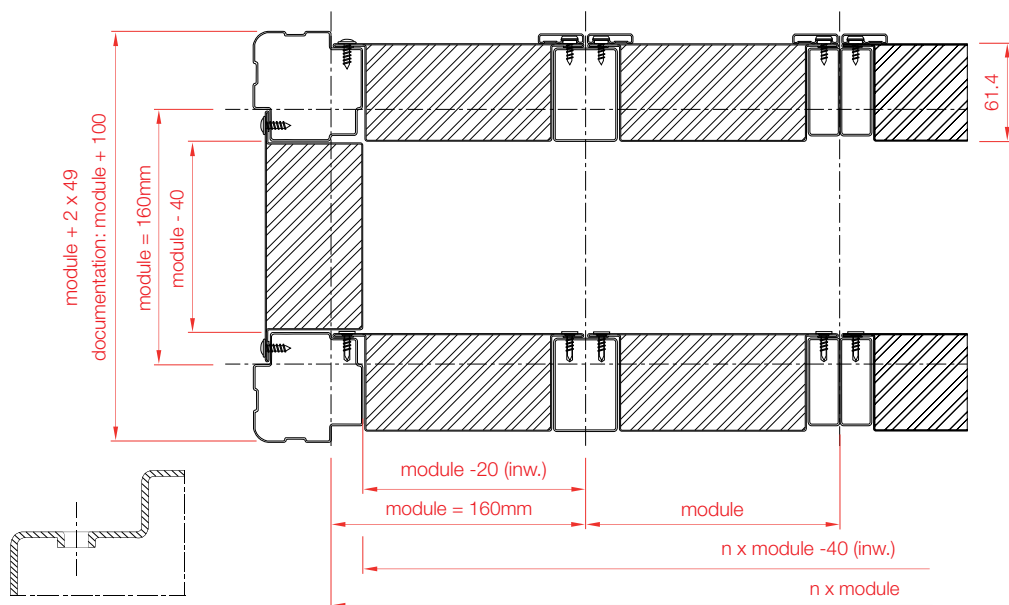
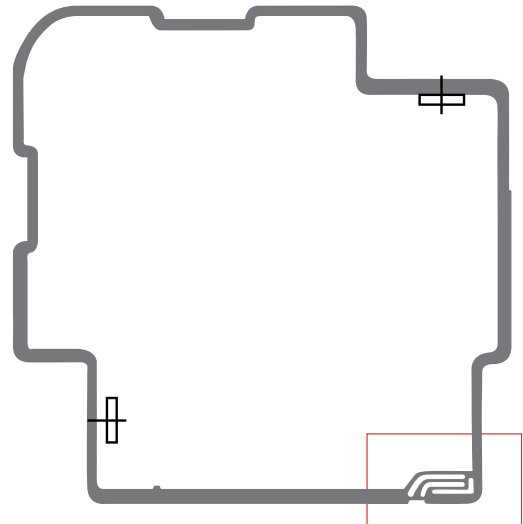
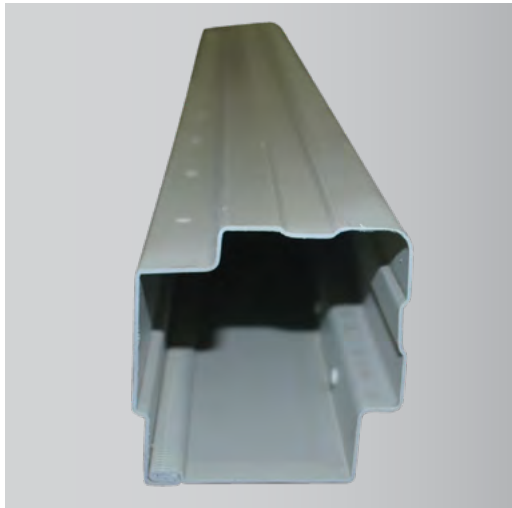

Side profile

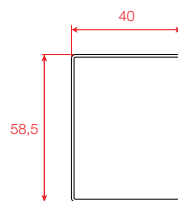

Main profile

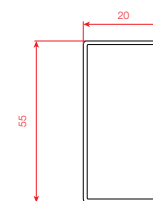

Connection profile (sectioning)

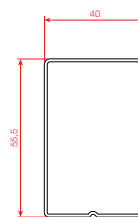

Door profile

4.2 Corners

Shock-proof ABS (Acrylonitrile-Butadiene-Styrene) plastic corner
Resistant against corrosion and hygienic



Corner

4.3 Base frame

Polyester coated powder painted galvanized steel with a thickness of 2 mm and density of zinc coating 225 gr/m² (Z225)

A- 62 mm (cross-section of rectangular carriage profile)

B- 160 mm (cross-section of round carriage profile)

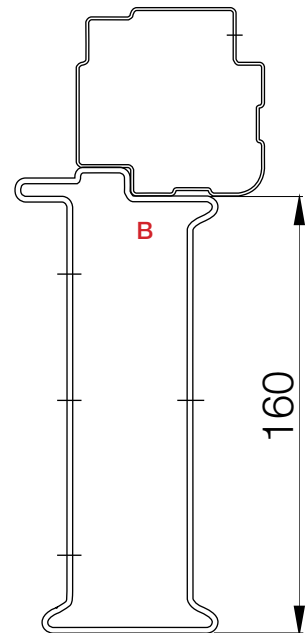
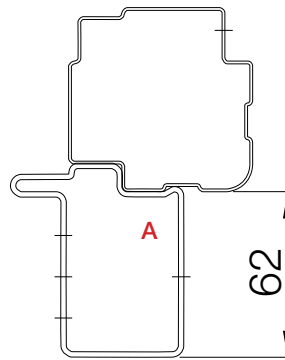

4.4 Panels

60 mm sandwich panel with double wall

Inner Plate: 0.8 mm

- Galvanized steel (standard) (zinc coating with a density of 160 gr/m² (Z160))
- or painted galvanized steel (zinc coating with a density of 225 gr/m² (Z225))
- or stainless steel (304 or 316)

Outer Plate: 0.8 mm or 1.25 mm

- Painted galvanized steel (standard) (zinc coating with a density of 225 gr/m² (Z225))
- or stainless steel (304 or 316)

Paint type: Pur-Pa (Polyurethane - Polyamide) powder paint. Resistant against 500 hours of salty water test.

- Colour code RAL 7035.

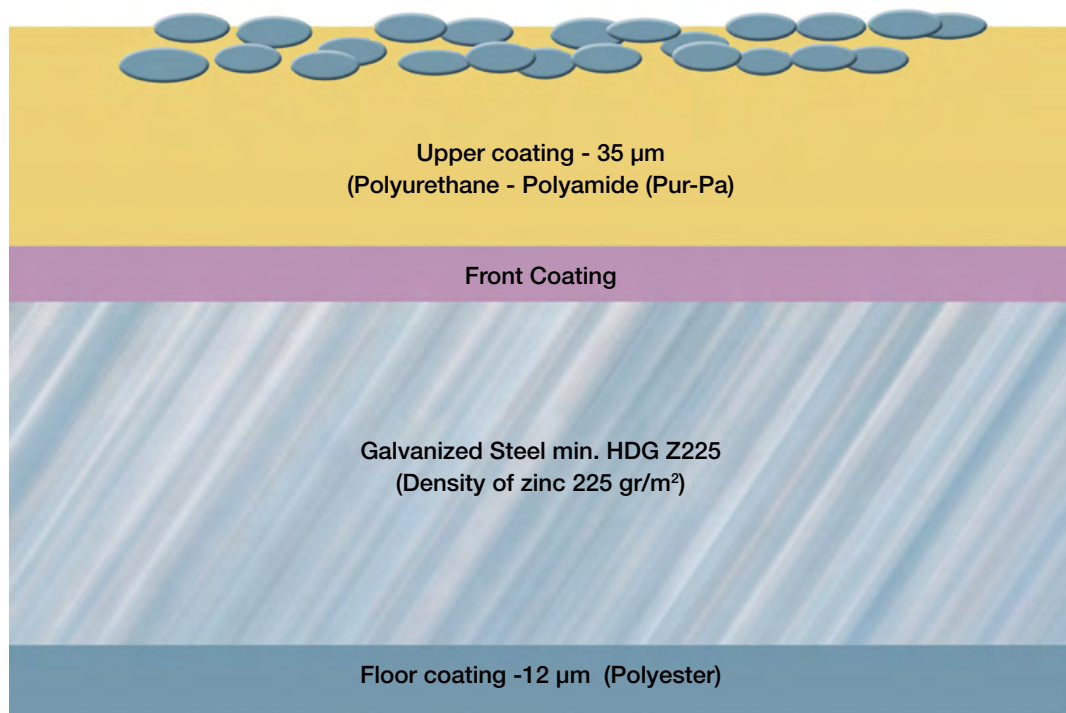
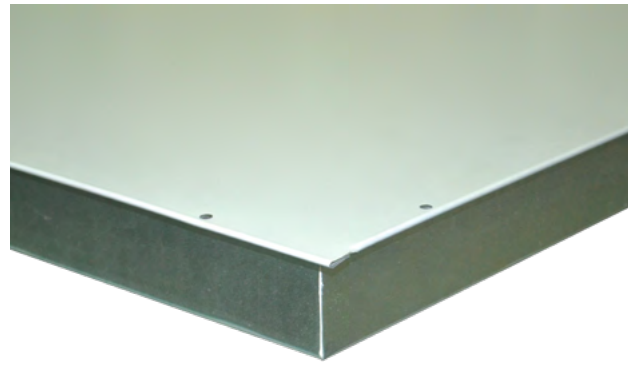
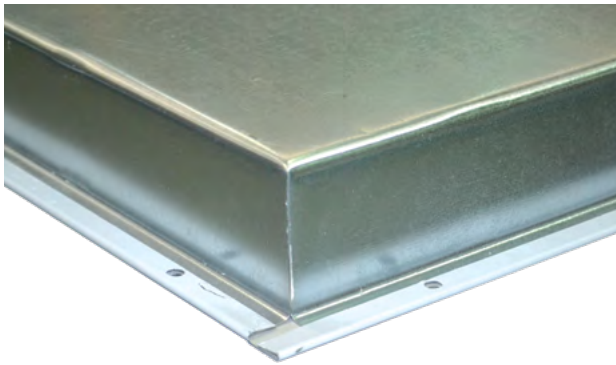

Panel coating

No additional holes are drilled on the panel while installing the panels to the profile.
 All panels are procured as completely closed in its insulation from the supplier.
 Fully closed panel design

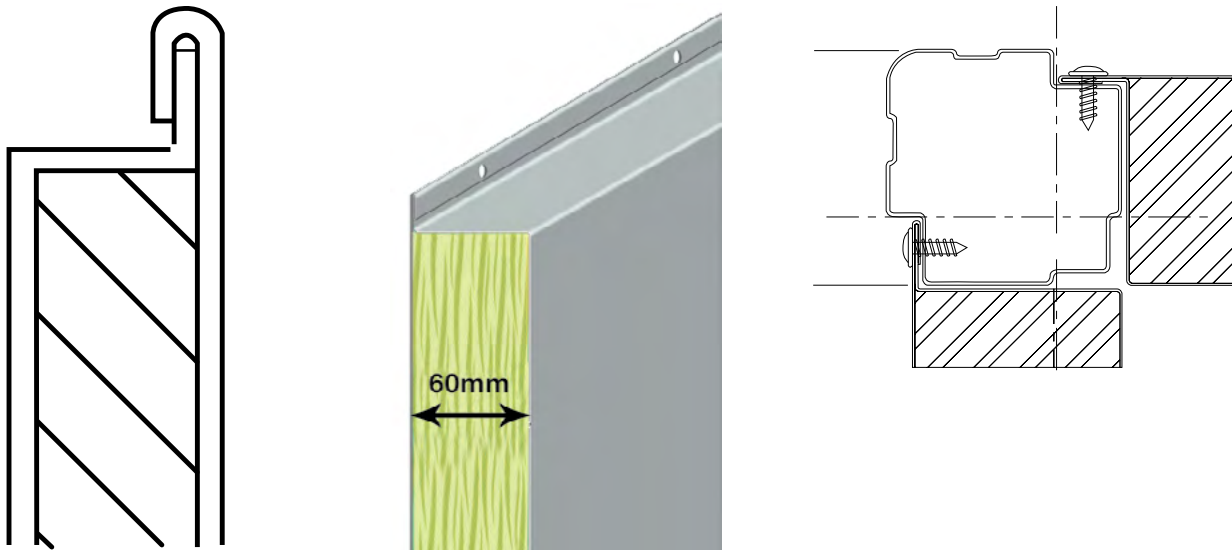

4.5 Insulation

IPN plates are installed in between to ensure strength even if the insulation type is selected as glass wool or rock wool.

Roof and side panels
 Glass wool (Standard)
 Mineral wool (Optional)

Floor panel
 IPN (Isophenic)
 Rock wool (Optional)

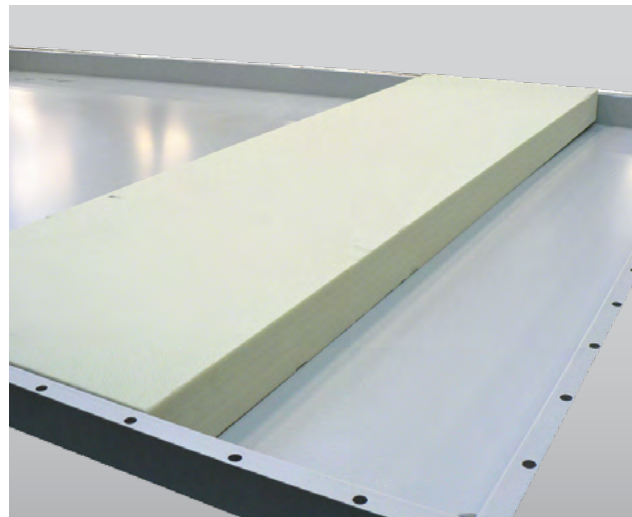
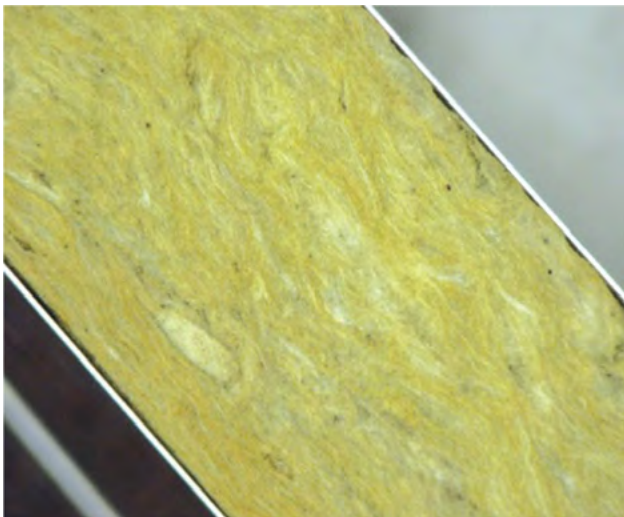

Floor is made of IPN material that allows the possibility to walk on it.

No	Material	Fire class (EN 13501-1)	Thermal transmittance (W/m ² K) (EN 12667)	Density (kg/m ³)
1	IPN	B-s2-d0	0,024	30 - 40
2	Glass wool	A1	0,035	23
3	Rock wool	A1	0,035	70

4.6 Screws

Interior Unit



Painted galvanized screw

Exterior Unit



Dacromet screw

4.7 Sealing Strips

Sealing strips are applied in panel connection places to minimize leakage through casing in all internal and external air handling units as standard.



Sealing strips

4.8 Connection Supports

39HQ air handling units are manufactured as cells as per their dimensions and then they may be assembled in the field. Cells are connected from the inside on the field and no connection parts are seen from the outside in terms of aesthetics.

As per the size of the air handling unit and the area of the sectioning, connection parts may be triangular from the corners or rectangular from the sides.

Connection strips are applied on the internal surface of air handling unit for extra sealing after assembly.

It is air-tight and maintains its thermal performance because of its connection method; and thus the surface of air handling unit maintains its smoothness.



Connection strip

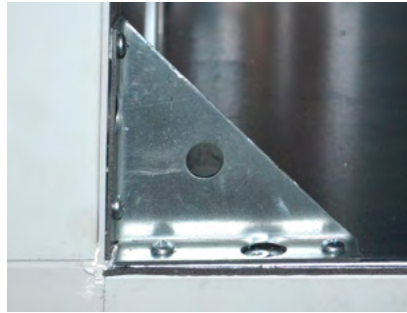

Triangular connection



Rectangular connection

4.9 Doors

Doors and intervention covers are important for accessing the components in case of any installation, service, maintenance or repair work for any machine or air conditioning equipment. However, amongst all air conditioning devices, accessibility is most important for air handling units in order to make an intervention inside the device. The reasons for this are the requirement for assembling the modules in the field as it is built as modular; the fact that each component is in different cells and that access to any component is very important in cases of maintenance and fault. Because it shall be easy to intervene for the maintenance, cleaning and repair of all components as it conditions the air which is the most important requirement for human health. Both in EN 13053 and DIN 1946/4 standards, one of the most emphasized points for hygiene in air handling units is the possibility of easy access to each component in case of maintenance, cleaning and faults.

All doors in the 39HQ air handling units are composed of sandwich panels with a thickness of 60 mm as any other panel in the unit. Thus the specifications of the body does not change whether a door or a cover is used.

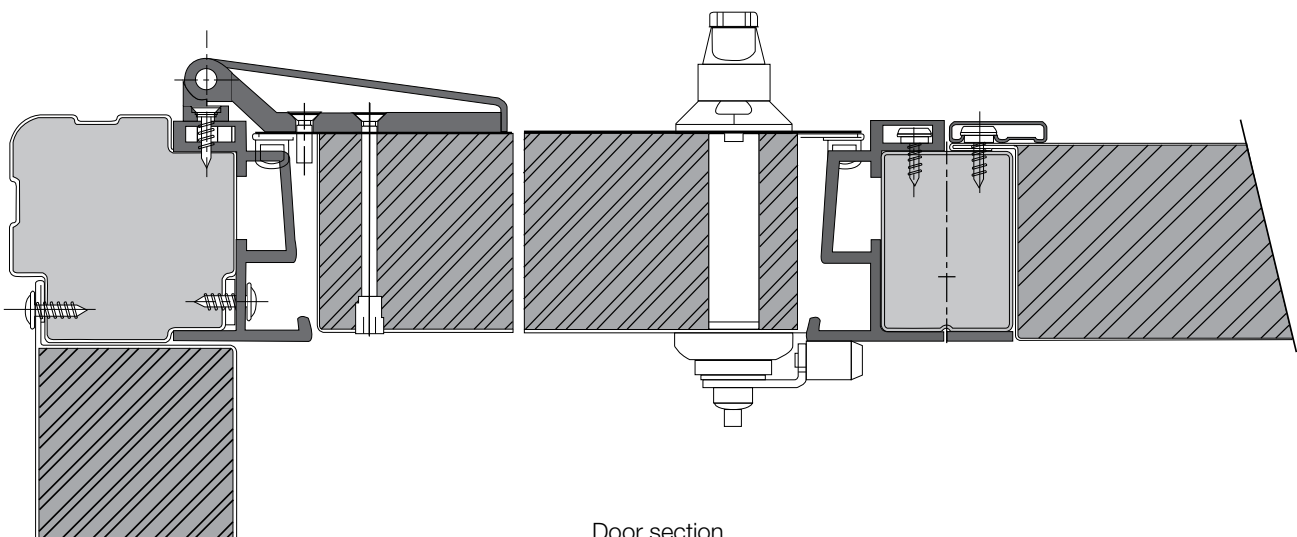

Door section



Special foam gaskets are used to provide air-tightness on door cells.



Door gasket

Interior surface of the air handling unit is completely smooth and there are no thresholds on the doors, thus it is possible to clean the air handling unit by sweeping potential dirt inside the unit easily from the doors to outside.



No thresholds on the doors

Hinged or hatch doors may be installed as optional on the cells where air handling unit components are available.



Hinged door



Hatch door



Inside joint connection kit



Unlocking mechanism from the inside (internal handle)

Door handles may be selected as T-handle, L-handle, L-handle lockable with double bit, L-handle lockable with key.



T-handle

L-handle

L-handle, lockable,
double-bit (8MM)

L-handle, lockable,
key (IL333)

Lock cylinder

- Features that provide safety and ease such as connection kits with inner joints for high doors,
- high pressure protection for positive pressure cells,
- door handles that allow opening the door from the inside are amongst the other functions of 39HQ air handling units.



Lock mechanism



Door hinge



Locking



Door key



Door high pressure protection
(pressure guard)

5 Exterior Installation

5. EXTERIOR INSTALLATION



Roof coating

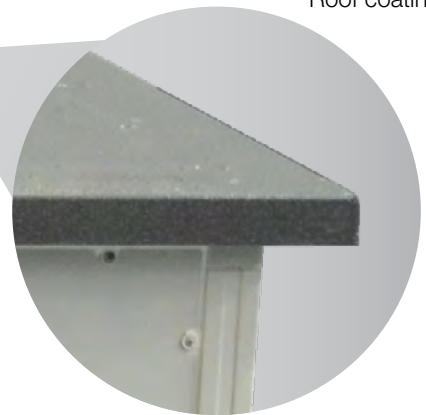

Stainless steel screw with plastic washer

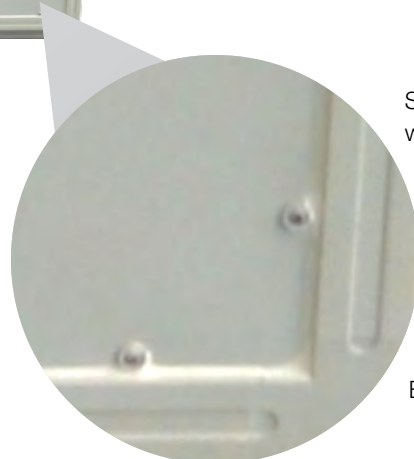

Extra silicone on corners

Following features are provided as standard for air handling units that shall be installed outdoors.

- Water- and UV-resistant roof material that is applied on the air handling unit with a special heat treatment
- Application of extra silicone on corners for better sealing
- Dacromet type screws with rubber gasket

Roof application is delivered as flat as standard; however, it may be delivered as sloped as an option if required.



Flat roof coating



Sloped roof coating

Louvres or cowls may be provided as an option on the fresh air intake or exhaust air outlet cells for air handling units that shall be installed outdoors.



Louvre

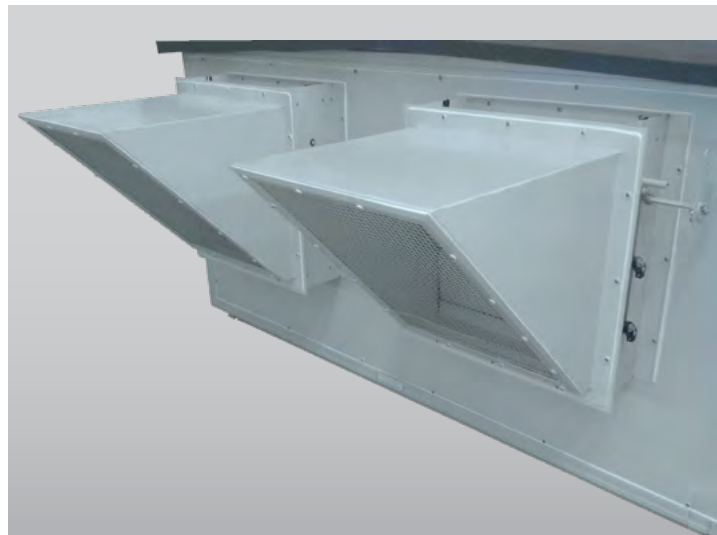

Cowl



6 Inlet / Outlet Mixing Cell and Dampers

Inlet / Outlet Mixing Cell and Dampers

6

6. INLET / OUTLET MIXING CELL AND DAMPERS

Dampers are used when it is required to adjust the flow rate of air or when the air flow is required to be turned off completely. Rubber gaskets are used to provide sealing on damper blade ends. It is possible to make any selection for inlet and outlet cells with the flexibility as specified below.

- Opening:
 - » Front connection (full face, top face, mid face, bottom face)
 - » Right or left side connection (full opening, half opening)
 - » Top connection (full opening, half opening)
 - » Bottom connection (full opening, half opening)
- Material: Galvanized or aluminium damper
- Damper blades: Opposite blade
- Damper position: Inside or outside the unit
- In accordance with standard EN 13053, the velocity on the damper shall not exceed 8 m/s (excluding circulation and bypass dampers).
- Dampers may be manufactured as painted as an option.
- The dampers have minimum Class 2 blade leakage class according to the EN 1751 standard and this class is documented with a certificate obtained from an independent testing organization.



Opposite blade damper with full face opening from front

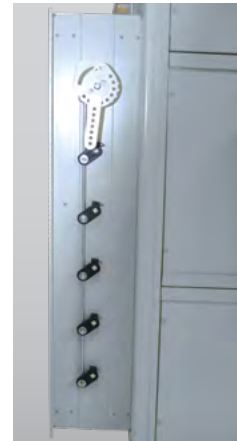

Damper movement mechanism



Damper motor inside and outside of the unit



- Flexible connection on the circulation air side are provided as standard on double deck units. In the inlet/outlet cells, flexible connections may be selected optionally as single-walled, single-walled with M0 non-combustibility class, double-walled and acoustic. Flexible connections are delivered with counter-flanges if they are selected. Standard flexible connection is made of polyester material with M1 non-combustibility class as per CSTB standard.
- Mixing cells are classified as cells with two dampers or three dampers. Mixing cells with two dampers are used when fresh air is mixed with return air. Mixing cells with three dampers have a return fan and while some of return air mixed with fresh air, remaining air is extracted with the third damper.
- Damper blade shafts are connected with a common drive system and therefore they move together. It is suitable for both manual and motor control. When coupling rod option is selected in mixing cells, a mechanism that allows linear operation of both dampers is provided.



Inlet / Outlet cell damper flexible connection (with counter - flange)



Coupling rod for dampers



Flexible connection for double deck unit mixing cell circulation damper



Mixing cell with two dampers

6 Inlet / Outlet Mixing Cell and Dampers



7 Filters

7. FILTERS

- Filters are divided into categories as per their particle permeabilities, material structures, intended uses and their placing inside the air handling units.
- Filters are inserted to the air handling units either by sliding from the side by a door or sliding from the front.



Side withdrawable panel filter



Side withdrawable combined filter
(panel + bag)



Front withdrawable bag filter

Classification of coarse, medium and fine filters as per EN 779:2012

Filter Group	Class	Final Pressure drop (Pa)	Average Arrestance (A_m) of synthetic dust	Average Efficiency (E_m) of 0,4 η m particles (%)	Minimum Efficiency of 0,4 η m particles (%)
Coarse	61	250	$50 \leq A_m < 65$	-	-
	62	250	$65 \leq A_m < 80$	-	-
	63	250	$80 \leq A_m < 90$	-	-
	64	250	$90 \leq A_m$	-	-
Medium	M5	450	-	$40 \leq E_m < 60$	-
	M6	450	-	$60 \leq E_m < 80$	-
Fine	F7	450	-	$80 \leq E_m < 90$	35
	F8	450	-	$90 \leq E_m < 95$	55
	F9	450	-	$95 \leq E_m$	70

Average Arrestance (A_m); Average Efficiency (E_m);
Average efficiency at 0,4 η m

Final pressure drop Minimum Efficiency of 0,4 η m

Classification of high efficiency filters for clean rooms as per EN 1822

Filter Group	Class	MPPS Integral Values		MPPS Local Values	
		Efficiency (%)	Penetration (%)	Efficiency (%)	Penetration (%)
EPA	E10	85	15	-	-
	E11	95	5	-	-
	E12	99.5	0.5	-	-
	H13	99.95	0.05	99.75	0.25
HEPA	H14	99.995	0.005	99.975	0.025
	U15	999.995	0.0005	999.975	0.0025
ULPA	U16	9,999,995	0.00005	9,999,975	0.00025
	U17	99,999,995	0.000005	999,999	0.0001

MMPS: Most Penetrating Particle Size **Efficiency:** Efficiency, **Penetration:** Penetration

Another filter type used for special applications in air handling units is the active carbon filters. Active carbon filters entrap and retain gas molecules. Surface of the active carbon filters consists of millions of small pores. Many odorous and poisonous gases are trapped by these pores.

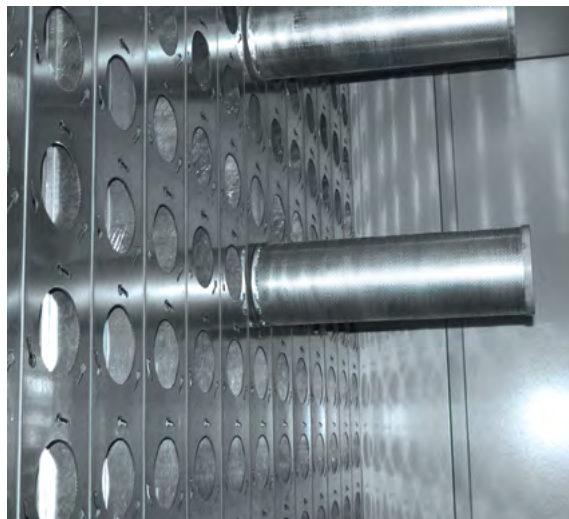

Active carbon filter



- Nuclear filters used in shelter air handling units and electrostatic filters used for absorbing the flue gases are other special filter applications used in air handling units.
- Another important issue for filters used in air handling units beside their permeability is their installation to the inner surface of the air handling unit. If proper sealing is not provided between the filter frame and inner surface of the air handling unit, air shall penetrate through the holes it can find and prevent the filter from operating efficiently. On this issue, there is a filter bypass leakage classification as per EN 1886 that measures the efficiency of the installation and that is also mentioned in the standards section.



Tightening clip for front withdrawable filter



8 Heat Recovery Systems

8. HEAT RECOVERY SYSTEMS

- Heat recovery systems are used for pre-conditioning the fresh air by using the energy of the exhaust air (by reducing the enthalpy of fresh air in summer time and increasing the enthalpy in winter time). Air thus pre-conditioned shall required less heating/cooling for the required supplying temperature and therefore, energy recovery shall be achieved.
- There are many parameters such as initial investment cost, application type, sealing, efficiency, pressure drop, conditions of interior and exterior air, fresh air ratio etc. for the selection of heat recovery type. Heat recovery systems in air handling units are classified into 4 classes.

- Wheel
- Plate
- Round Around
- Heat Pipe

8.1. Wheel Type Heat Recovery

Wheel type heat recovery is also classified into three classes as per the heat transfer surface of the heat recovery wheel.

- Condensation
- Enthalpic
- Sorption

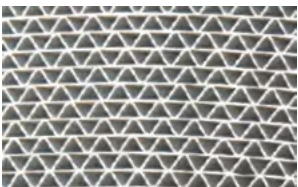
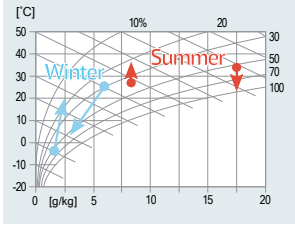
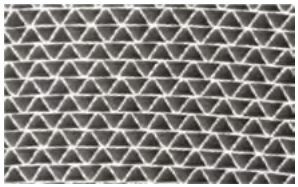
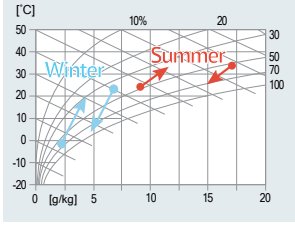
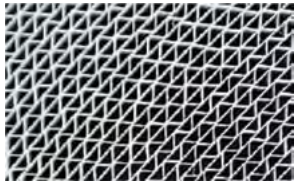
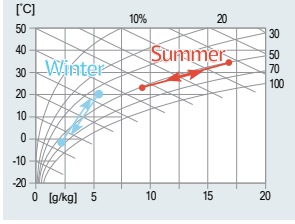
Wheel type	Heat transfer surface	Psychrometry	Heat transfer	Application type
Condensation			Only sensible, latent heat transfer in case of condensation	On systems without humidification and cooling
Enthalpic			Sensible and limited latent heat transfer	On systems with humidification and without cooling
Sorption			Sensible and latent heat transfer (through all seasons)	On systems with humidification and cooling

A gap on both upper and lower sides of the wheel shall be provided in wheel type heat recovery systems for installation and intervention when required and access to these cells shall be available by a door.

Wheel type heat recovery systems are the most efficient ones. There is always air mixture, even if very little, between fresh and exhaust air in wheel type heat recovery systems. Although it is possible to reduce the amount of this air mixture using a purge sector but it cannot be completely removed any way.

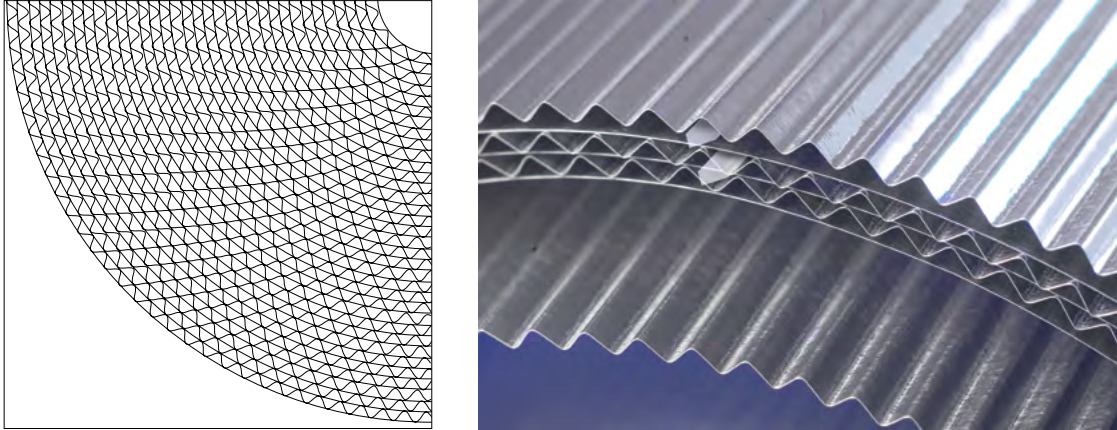

Wheel heat transfer geometry

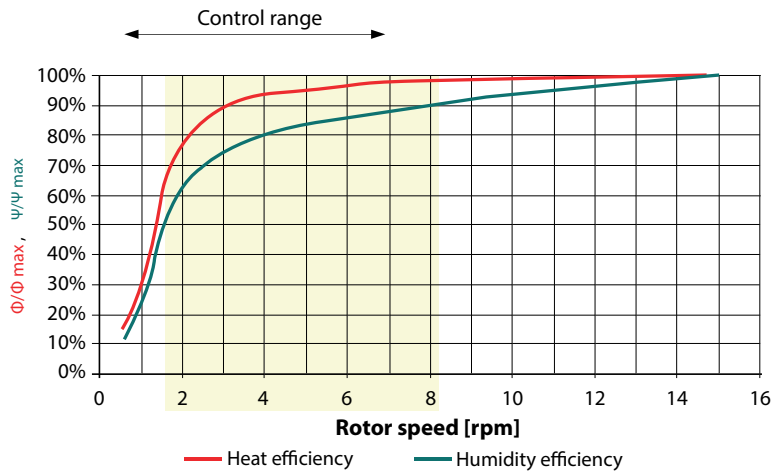

Dependence of the efficiency on the rotor speed



Wheel type heat recovery



Wheel inspection port



Heat Recovery Systems

8



Heat wheel with bypass dampers



Rotor purging sector

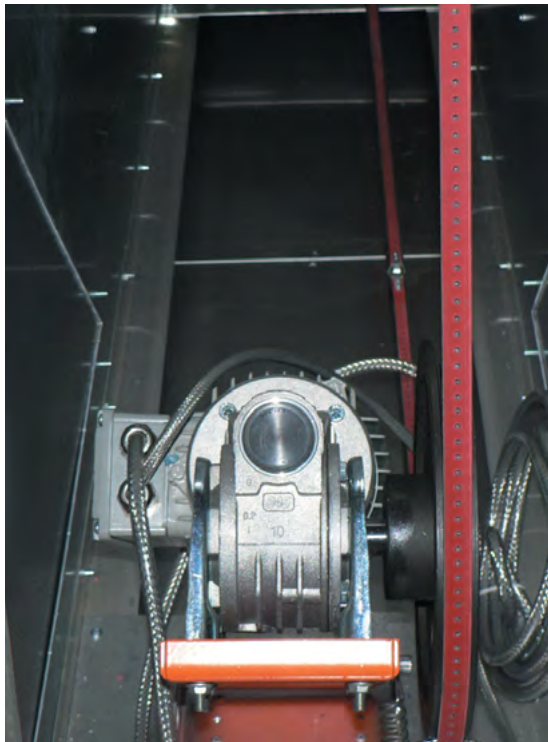

Wheel motor

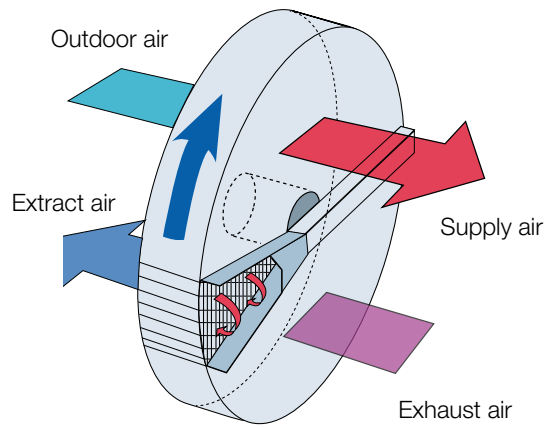

Rotor controller

8.2. Plate Type Heat Recovery Systems

Exhaust and fresh air never mix with each other in plate type heat recovery systems. These systems may be delivered with bypass dampers as an option. Plate type heat recovery cell is equipped with a tray that covers whole it's floor, inside of whole pan is covered with a special epoxy material and an outlet is provided from the bottom for draining. Although cross flow is used usually for plate type systems, high efficiency systems with counter flow may also be used for systems with lower flow rate. Multiple air ducts created by the fins allow heat transfer, thus heat recovery, between the extract air and intake air. Heat transfer occurs between these two airs, there is no humidity transfer. Extract air and intake air passes crosswise through the exchanger. The fact that the positions of intake air and extract air are close to each other, that these airs mix with each other at a low rate, and that it does not have a moving part are typical features of this system.

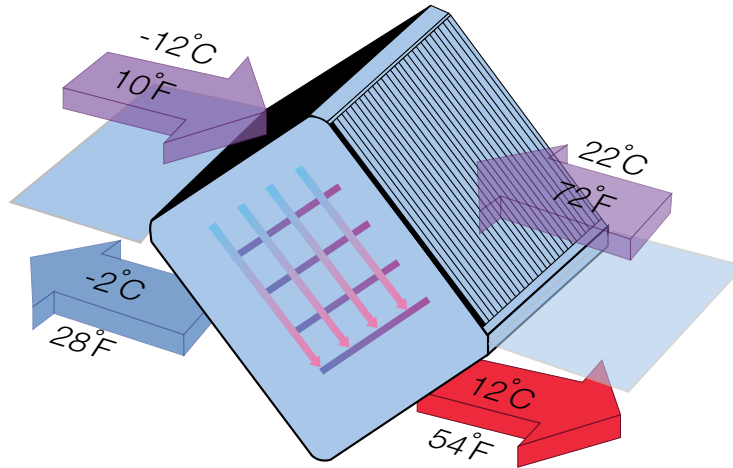

8.3. Round Around Coil Type Heat Recovery Systems

Initial investment cost and efficiency of round around coil type heat recovery systems are lower than the other systems. As it is composed of completely separated coils, it shall not be placed inside the same cell or on top of each other. Another advantage is that the exhaust and the fresh air do not mix.

It provides heat transfer, thus heat recovery, between the exhaust air and fresh air with two or more coils, a circulation pump and a control system. It is a heat exchanger of the sensible type. Heat transfer occurs between two airs, there is no humidity transfer. The positions of fresh air and exhaust air may be away from each other; the fact that these airs do not mix with each other and that it does not have a moving part are typical features of this system.

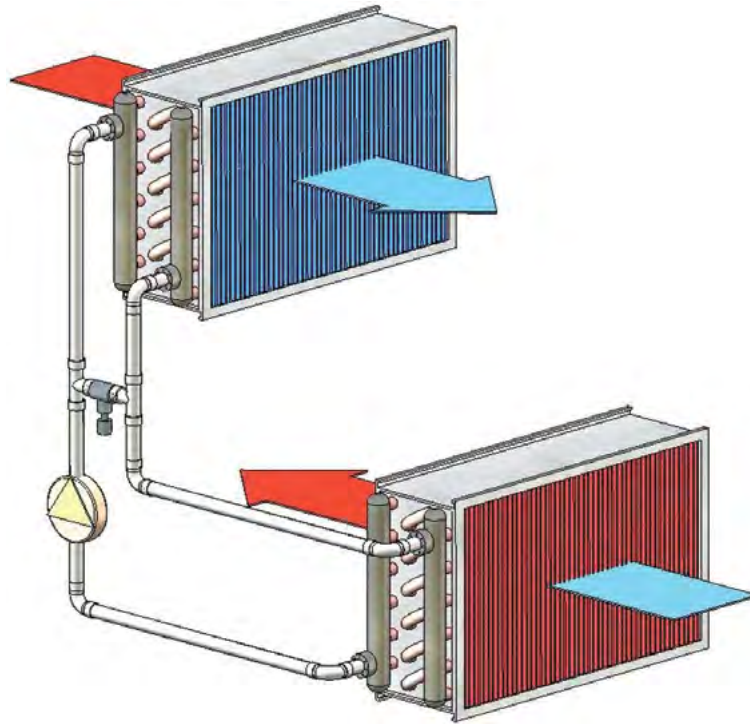

8.4. Heat Pipe Type Heat Recovery Systems

Heat pipe type heat recovery systems are divided into two as horizontal/vertical type heat pipe and horse shoe heat pipe type heat recovery systems. Heat pipe systems usually include refrigerant instead of water inside the pipes as similar to the coil type systems.



8.4.1. Horizontal/Vertical Heat Pipe Type Heat Recovery

This is a typical pipe / fin exchanger that is composed of two sections that operate as a condenser and an evaporator and that has proper amount of refrigerant inside. Air, of which it's heat shall be extracted, is taken through the evaporator side and it's heat is transferred to the refrigerant. Vaporized refrigerant transfers it's heat to the cold air passing outside of the exchanger on the condenser which is placed higher, and thus heat is transferred to the cold air and heat recovery is ensured. It is of the sensible type, heat transfer occurs between two airs, there is no humidity transfer.

8.4.2. Horse Shoe Heat Pipe Type Heat Recovery

Horse shoe heat pipe type heat recovery exchangers are heat pipe types that are used for dehumidification operations in air conditioning systems. It performs pre-cooling of the air that shall be dehumidified and and reheating of this air with the energy taken. Thus, energy consumption is not required for both processes.

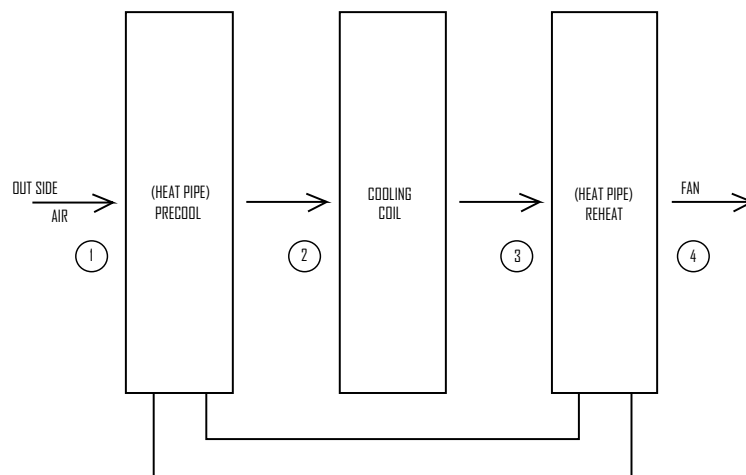
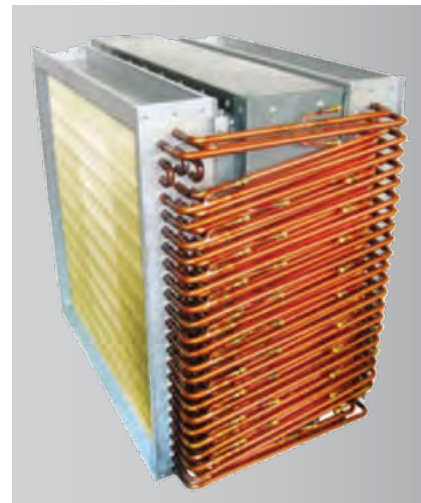
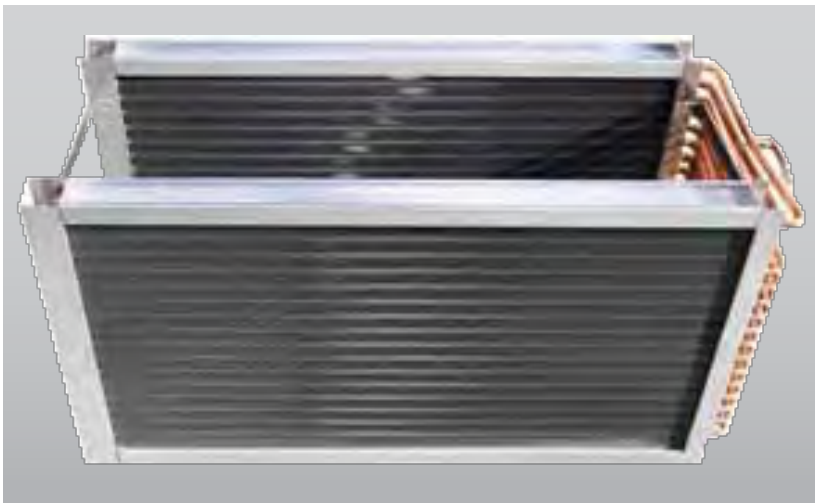



9 Coils

9. COILS

Heat exchangers used for heating, cooling and/or dehumidifying the air in HVAC systems are usually of the finned pipe type and they are called as coils. Air to be conditioned that flows outside of the finned pipes contact the fin surface. A heating or cooling fluid is circulated inside the pipes. Coils may be hot water coils, cold water coils, DX coils and vapor coils. As Alarko Carrier, we manufacture the water coils for air handling units and DX coils for rooftop units in our own coil workshop. Besides that, coils can be supplied from other coil manufacturers based on business.

All water and DX type coils manufactured are tested with pressurized air test in the water pool inside the factory. Test and operation pressures according to coil and collector types are shown in the table to the right.

Coil (Collector) Type	Test Pressure [Bar]	Operating Pressure [Bar]
Steel Collector (Water)	30	4-16
Copper Collector (Water)	16	4-10
DX Coil	34/48	21-32

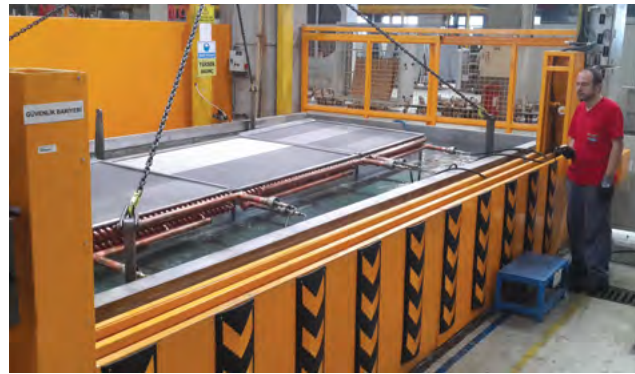

Coil production workshop

For all Water or DX Coil Types,

- it is possible to select freezing protection and measuring nipple options.
- During the installation of coils inside the air handling unit, they are surrounded by bypass plates to prevent bypass of air.
- Pipe connection holes on the pipe outlets of the coils are closed with air-tight gaskets.



Frost protection and thermostat



For the interior unit



For the exterior unit



Measuring nipples



For all Water or DX Coil Types,

Optimum coil is selected by offering the user information such as pipe connection direction, pipe and fin material, pipe thickness, fin thickness and interval, coil frame material etc.

Pipe material;

Copper or electro-tinned copper

Fin material

Aluminium, coated aluminium (polyester coated gold-fin) or copper (electro-tinned copper may also be selected if it is a water type coil)

Coil frame material

It is possible to select steel, and 304 or 316 stainless steel.

DX (Direct Expansion) Coils

DX coils are used inside the air handling unit as indoor unit of the cooling circuit and in air handling units specified as packed system as the outdoor unit. As the usage of VRF units have increased in the recent years, number of applications where VRF outdoor unit and indoor unit with DX coil are used inside the air handling unit are increased.

Pipes of DX coils are taken out of the air handling unit as standard in the factory and the holes opened are sealed. Thus, the installer on the field does not have to drill a hole on the body of air handling unit.

Dx coil collectors are also made of copper.

DX coil inlets are manufactured with distributors and with return connection from the top and intake connection from the bottom.



Positioning of coils inside the air handling units and the velocity of air are important criteria. As more air passes through the coil when the air velocity is increased, it is possible that the capacity of the coil may be increased but the efficiency of the coil shall be decreased, pressure drop shall be increased and the possibility of drifting water to the other components with the air for condensed coils. Therefore, air velocity shall not be selected over the velocity required by the project. Also, for reasons of hygiene, DX coils and cooling coils shall not be placed just before cells such as filters and silencers. Droplet eliminators made of plastic or galvanized steel may be selected to reduce the possibility of drifting of water with the air after the cold water and DX coils. Plastic droplet eliminator is made of polypropylene material that is resistant up to 120 °C. Also, DX and cooling coil selections allow selection from software as per wet or dry operation pressure drops. Dry and wet selections affect the SFPv and SFPe values of specific fan power. There is sloped drain pan made of stainless steel that shall also completely cover the droplet eliminator section under the DX and water type coil cells. Drain pan can be selected as 304 or 316 type stainless steel. Syphon for draining the water collected in the drain pan is delivered as standard with the air handling unit. Syphon provided could be used for both positive and negative cells.

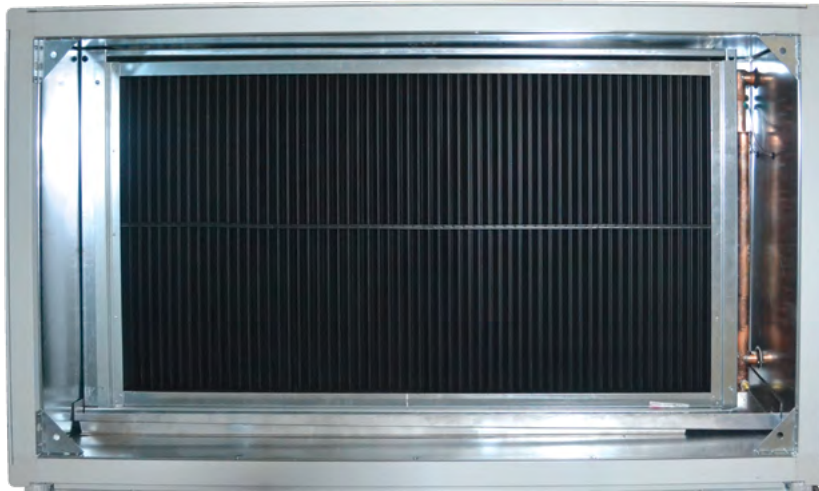

Droplet eliminator



Sloped drain pan



Syphon



Water Type Coils

- It is possible to use water with ethylene or propylene glycol with the percentage specified in the selection software besides normal water in water type coils.
- Water type coil collectors may be selected as copper or hot dipped steel. Steel collectors are painted with electrostatic spray applied epoxy based wet paint after the coil manufacturing and testing stages.
- Pipe connections are threaded as standard. They may be provided with flanges or with counter-flanges when required.
- Drainage outlet on the bottom and air purger on the top are provided as standard on water type coils.
- Water type coils are counterflow type and they are manufactured so that water inlets are from the bottom and returns are from the top.



Collector



Flange



Counter-flange

Withdrawable frost thermostat option is available on hot water coils.

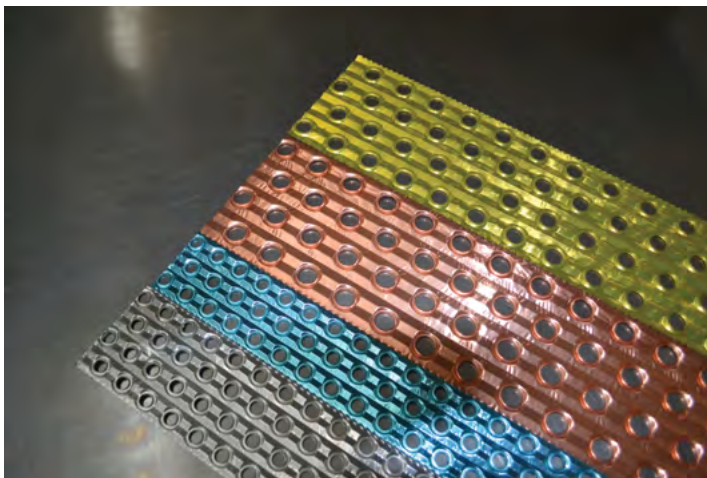

Aluminium, blue-fin (polyurethane coated), copper, gold-fin (polyester coated) fins



Air vent and drain plug

10. ELECTRIC HEATERS

- Body of the electric heaters are made of Aluzinc coated steel (AZ 185) with corrosion class of C4 and their heaters are made of stainless steel.
- Protection class is IP43 as standard. It may be delivered as IP55 or IP65 as an option.
- Temperature thermostats with automatic reset (75 °C) and with manual reset (120 °C) are available on these components as standard.
- These are delivered as multi-stage controlled as standard, however, they may also be delivered with proportional control as an option. Air flow switch option is also available.
- Cable connection holes are drilled on the hole for easy power connection on the field and hatch door is provided as standard.
- Terminal box including wiring connection details is installed on the air handling unit.
- Cable glands are provided with proper combination for installation from upwards or downwards.
- Heaters are distributed equally inside the casing of air handling unit.



11 | Humidifiers



11. HUMIDIFIERS

Although humidifiers are classified with many different methods in different literature, they are categorized as follows by their manufacturing methods as per EN 13053 standard:

11.1 Spray Type Humidifiers:

- 11.1.1 Air Washers
- 11.1.2 Ultrasonic Humidifiers
- 11.1.3 High Pressure Humidifiers

11.2 Evaporative Humidifiers:

11.3 Steam Humidifiers:

Humidifier is one of the most important and critical components of the air handling unit. It is very important that length of humidifier section is sized properly to prevent drift of water drops to the components after the humidifier. Also, the drain pan and the draining of the water shall be considered with care as it is cell that contains water and steam.

Any of these different types may be applied inside the air handling unit according to the requirements and sensitivity of the system during the project design stage.

304 type stainless steel drain pan is applied in the humidifiers in 39HQ air handling units. 316 type stainless steel drain pan can also be selected as an option.

Steam humidifiers that may be procured from different manufacturers are installed inside the unit with multiple distribution nozzles.

Pipe connections may be performed from the right or left as requested.

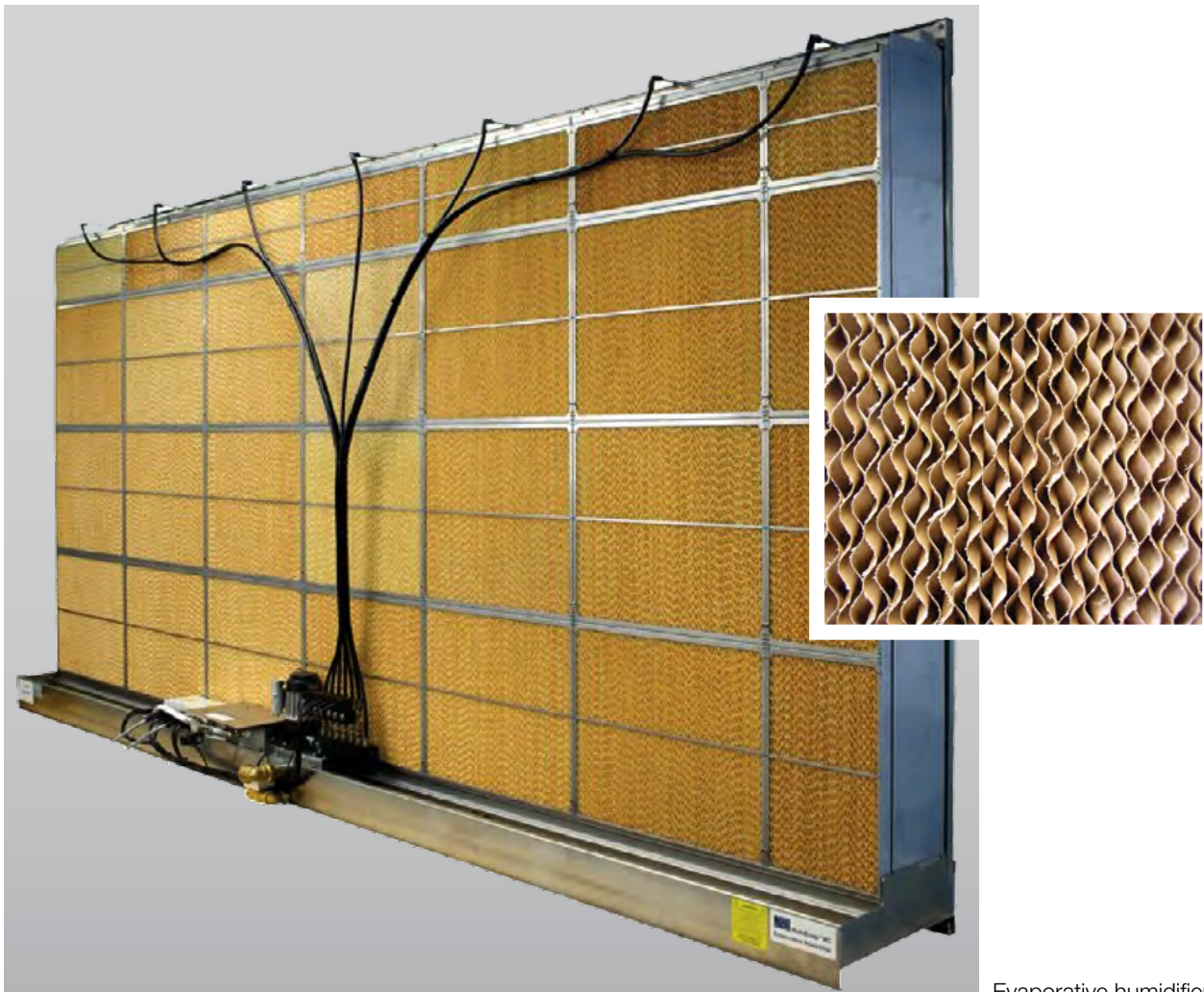

Evaporative humidifier



Spray Type Humidifier



High Pressure Humidifiers



Water / Pressurized Air



Hybrid



Steam Humidifier application inside the air handling unit



12 | Fans

12. FANS

Fans used for pressurizing the supply or return/exhaust air in the air handling units may be of many classification groups as per the application or requirement. (with forward and backward curved blades, belt-driven or direct-driven (plug, EC etc..))

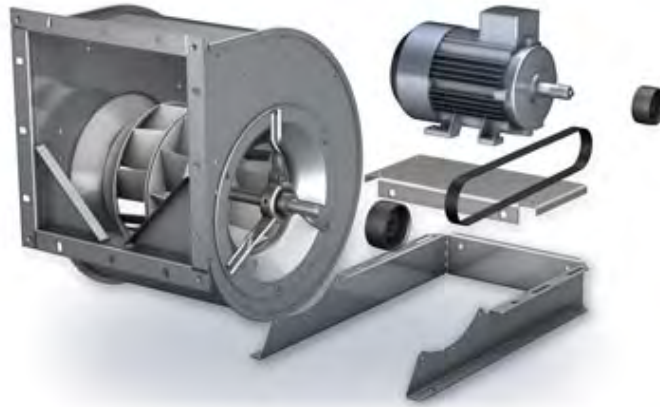

Belt-driven fans

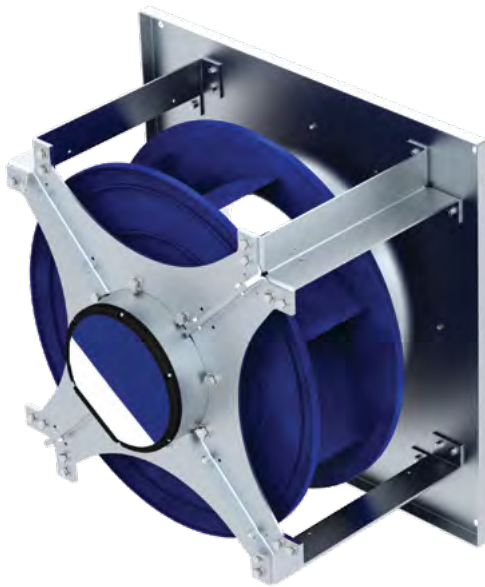

EC fans



Plug fans



Air Velocity (m/s)

Average air velocities in the fan body are classified below as per EN 13053 standard.

Class	Air velocity m/s
Class V1	Maximum 1.6
Class V2	> 1.6 to 1.8
Class V3	> 1.8 to 2.0
Class V4	> 2.0 to 2.2
Class V5	> 2.2 to 2.5
Class V6	> 2.5 to 2.8
Class V7	> 2.8 to 3.2
Class V8	> 3.2 to 3.6
Class V9	> 3.6

System Effect

Fan selection is performed by calculating the pressure losses due to system effect in the Airovision Builder air handling unit selection software.

Fan Data		
Total air volume	6.00	m ³ /s
Speed	1353	rpm
Maximum speed	2000	rpm
System effect	168	Pa
Total static pressure	459	Pa
Dynamic pressure	84	Pa
Total pressure	543	Pa

Minimum classes for fan motors shall be IE2 for efficiency, IP 55 for insulation, and F for protection. Higher classes can be delivered as option.

Fan motor can be installed outside of the air flow for fan motor connection direction, double fans, standby motor or special applications.



Dual fan

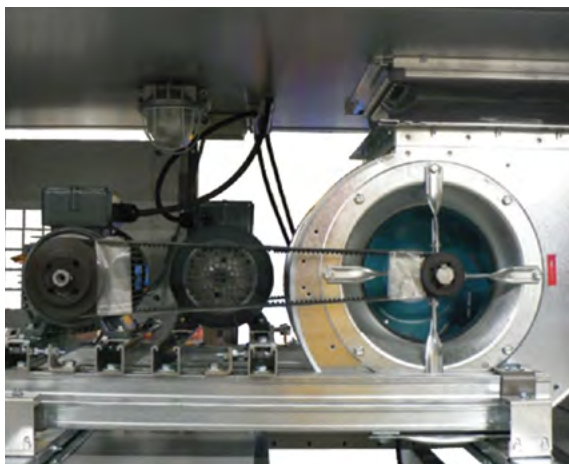

Run & standby motor



Dual fan and run & standby motor

Accessories

Fan cells have doors as standard. Besides that, accessories such as door size, connection direction, sight glass, light armature, light switch, pressure gauge, pressure switch and measuring nipples may also be added. Some other accessories used in fan cells are shown below.



Drain plug



Inspection hatch



Inlet cone
measuring points



Drive guard (wire mesh)

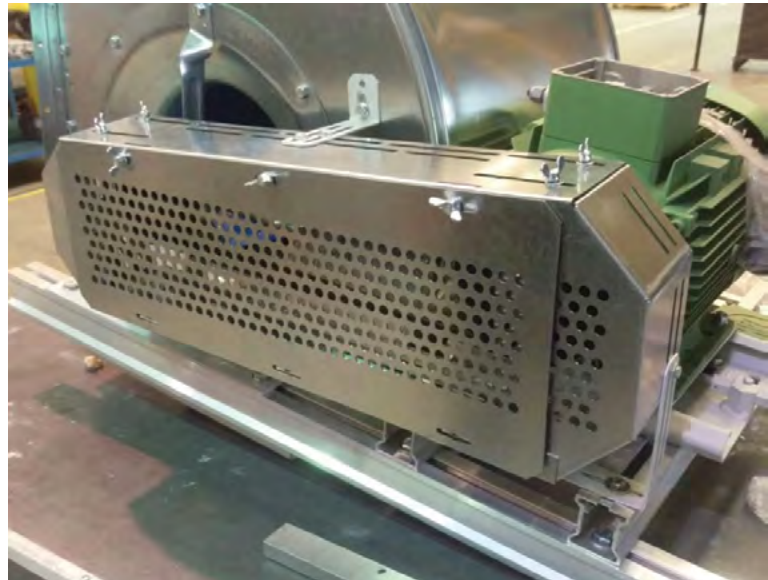

Drive guard (closed)

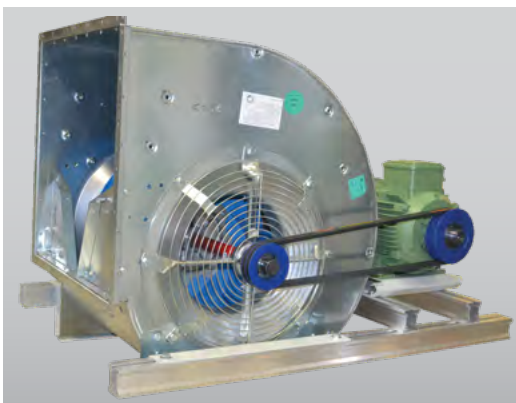

Fan inlet guard

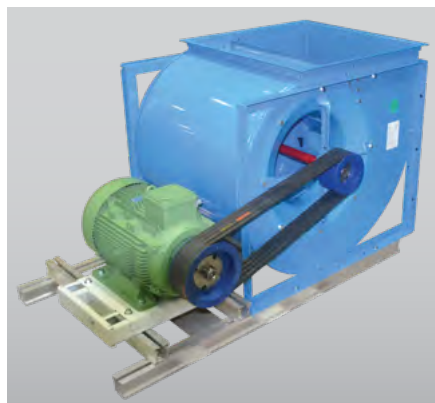

Epoxy painted fan



M0 fire class fan
flexible connection



Inverter* (IP 20 or IP 55)



Fan emergency stop button

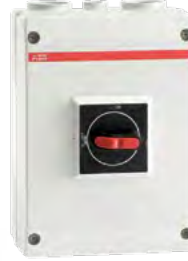

Isolator, fan

IPN (isophenic) type insulation is used as standard on the floor panel of air handling unit to provide high mechanical strength. Vibration dampening types of fans in the air handling units are shown below. In order to dampen the vibration on the fan pedestals, rubber mounts are used for fans with a fan rotor diameter under 280 mm, and spring dampeners are used for fans with a fan rotor diameter over 280 mm.

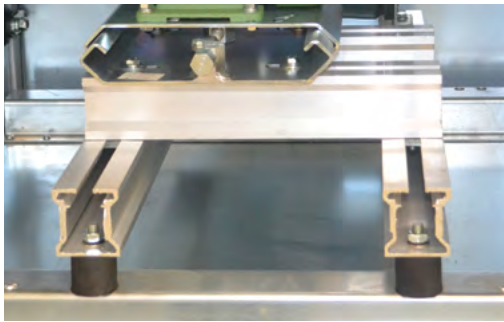

Rubber anti vibration mounts



Spring anti vibration mounts



Belt-driven centrifugal fans after assembling the fan and the motor parts in the factory, electrical, speed control, belt alignment, vibration and balancing tests are performed for each fan and fans are installed inside the air handling unit after the quality control tests.

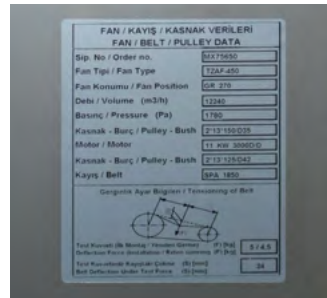

A warning label is available outside of the fan cell and an informative label is available inside the fan cell.

*Delivered inside the unit with it's package so that it shall be installed in the field.

13 Diffuser

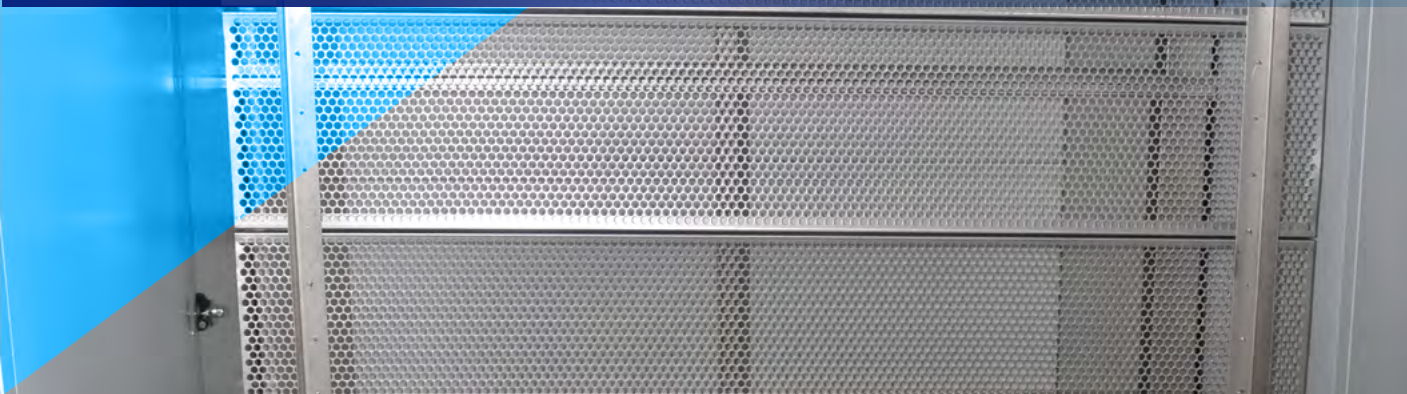

13. DIFFUSER

Diffusers are used for smoothing the turbulanced flow after the radial fan cells.

They would be delivered as removable as an option.

They are manufactured from galvanized steel as standard. It may be delivered as painted galvanized steel or 316 type stainless steel as an option.



14 Silencer



14. SILENCER

Noise absorption values of the silencer are calculated as per ISO 7235.

Silencer cartridges are placed inside the air handling unit with intervals shaped as rectangular prisms and so that their installation shall prevent deformation and conform with noise absorption principles.

Cartridges are made of galvanized steel, noise absorbing sections are made of inorganic, mineral wool material that meets the flame spread requirements specified in DIN 4102 Class A-1. Surfaces may be manufactured with perforated plates as an option to increase the noise absorption.



15 UVC Lamp

15. UVC LAMP

UVC lamps are used to kill the microorganisms inside the air handling units. «UV» defines whole «UltraViolet» wavelength spectrum. And «UVC» term defines the short wavelength which is the most lethal for germs within UV rays. (wavelength of approx. 250 nanometres)

These are not the equivalent of filters as they do not have a retaining function as filters. Therefore, they are recommended to be used together with the filter systems. Particles inside the air trapped by the filters, but very small microorganisms and the mold that threaten human health and that cannot be retained by the filters are killed within a period of time by damaging their DNAs with UVC lamps. These lamps also reduce the requirement for general maintenance and cleaning of units by preventing spreading of bacteria, mold, spores and odours in the coil area. 19 mm UVC quartz lamps with high density are used.

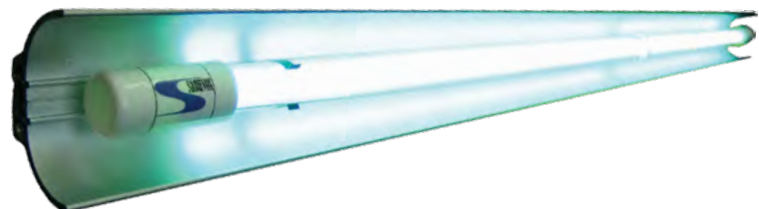
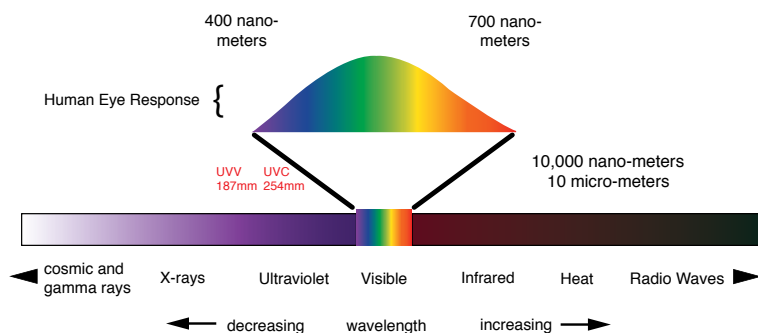

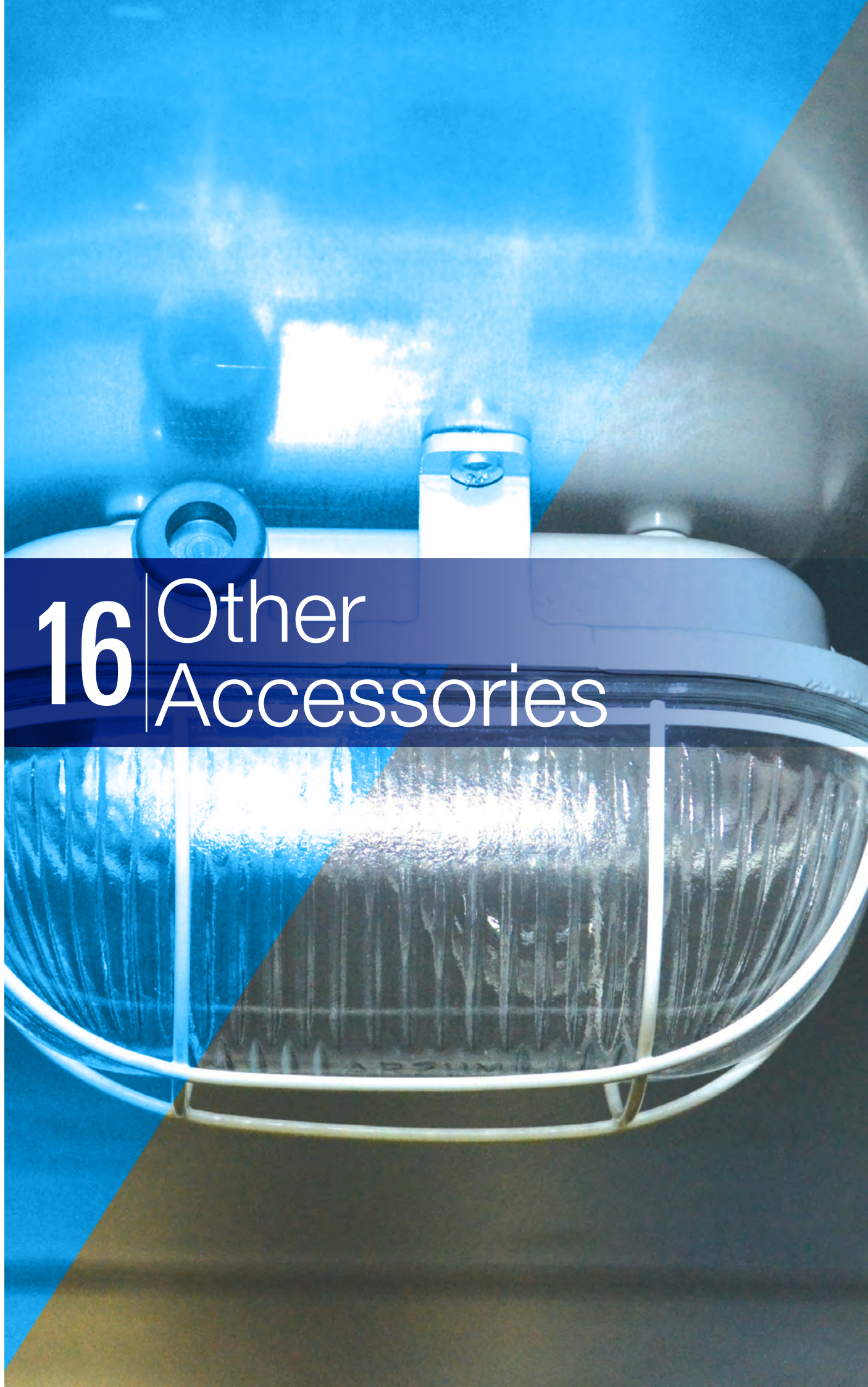

16 | Other Accessories

16. OTHER ACCESSORIES

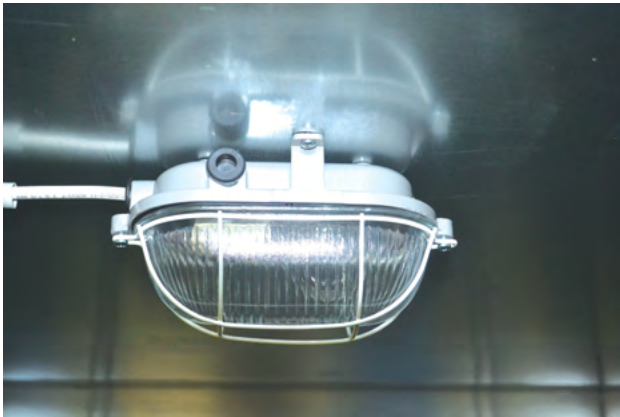

Light armature



IP54



IP55

Light switch



Measuring nipples



Sight glass



Pressure gauge

Pressure switch

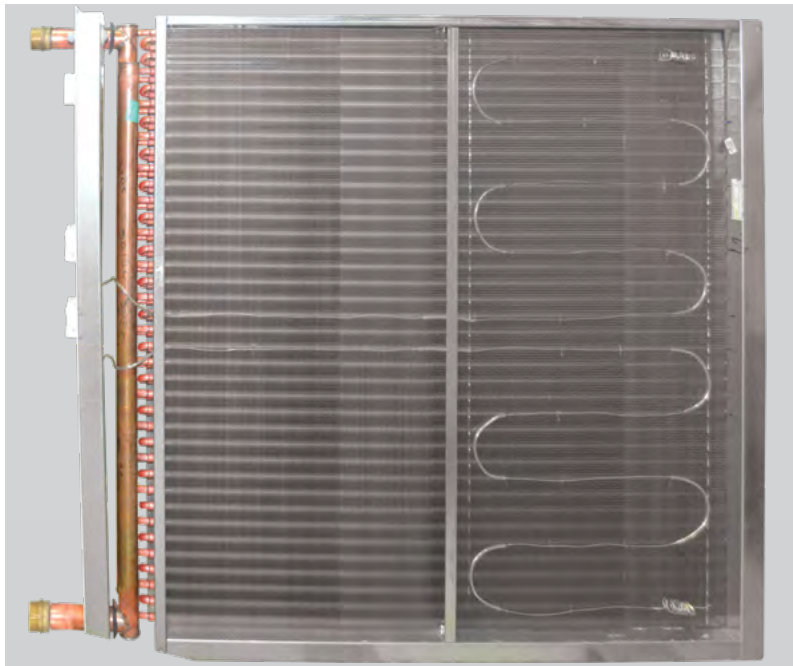

Frost protection and it's thermostat



For the interior unit



For the exterior unit



Inverter* (IP 20 or IP 55)



Isolator, fan



Rotor controller



Internal or external damper actuator



Coupling rod for dampers

*Delivered inside the unit with it's package so that it shall be installed in the field.

17 Control



17. CONTROL

Automatic control system that allows remote management of air handling units used for enhancing the air quality and quality of life in crowded areas such as hospitals, malls, hotels, educational institutions, business centres, banks, public institutions, cultural centres, theatres, airports etc. has also become an integral part of the air handling units. While it is possible to perform positioning or switching, automatic or manual operation of the components of the unit with this system, it is also possible to receive information such as faulty component, operation, dirtiness, freezing etc. Also, this system allows monitoring of measurements such as temperature and humidity, air quality etc. on a Controller with the measurement equipment used. DDC Panel required for SCADA are manufactured as specific for each project with Automated Logic PLC boards with the assurance of Alarko Carrier so that they shall be environment-friendly, safe, light, easy-to-maintain, high quality and warranted. While, a Carrier brand, Automated Logic products are used in 39HQ AHUs.



Technical Specifications:

- Provides solutions that offers plug & play operation by leaving the customer the requirement for power supply only,
- Where the procurement, installation and testing of automated control equipments are completed in the factory,
- Where automation software and testing of these software are completed in the factory,
- Where the procurement and installation of MCC-DDC panels on air handling units are completed in the factory,
- Where the procurement and installation of power and control wiring with terminal connections and the procurement and installation of cable spirals are completed in the factory,
- Where ease of installation is provided with special connectors used between the air handling unit modules,
- Where customer is correctly directed about operation and maintenance with the labels used and thus possibility of errors are eliminated.

Control Options: • Flow Control • Temperature Control • Humidity Control • Differential Pressure Measurement • Emergency Stop





17.1 Control Panel

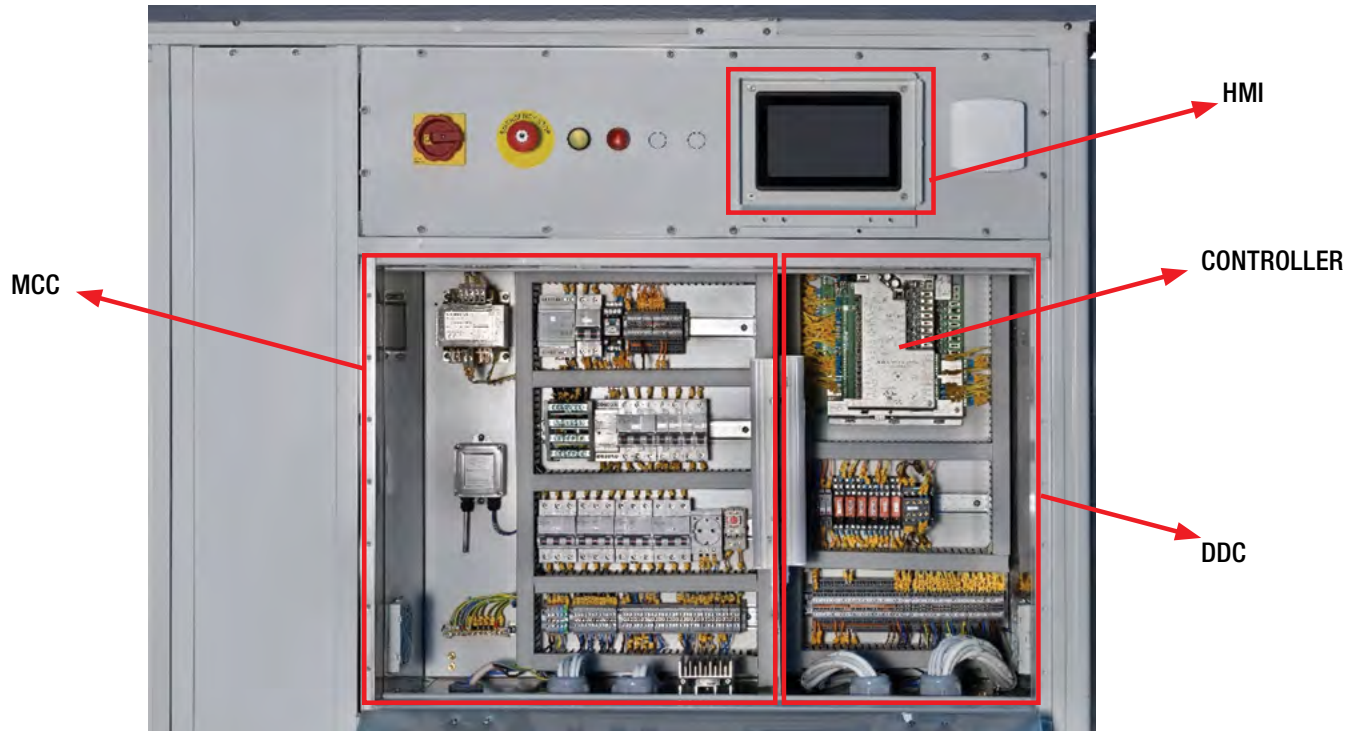

17.1.1 External Panel

The control panel is hung on the device from the outside. Cables are connected to the control panel by junction boxes on each sections.



Integration

Unit supports BACnet-IP as standard. Modbus TCP/IP or Modbus RTU protocol can be selected.



Connection

39HQ air handling units have modular structure and it is delivered section by section. Each sections have junction boxes and they are connected each other. Nearest junction box is connected to the control panel.



17.1.2 Internal Control Panel



Cabling

Internal signal and power wiring are carried out separately via different connectors and cable conduits.

Communication

Unit supports BACnet-IP as standard. Modbus TCP/IP or Modbus RTU protocol can be selected.



Connection

39HQ air handling units have modular structure and it is delivered section by section. Cable connections between sections are carried out by connector. Connectors prevent wrong connection.



17.2 Controller

28 Input, 16 Output.

- Supports up to 9 FIO expanders
- BTL certified and conforms to the following device profiles:
 BACnet Building Controller (B-BC) BACnet BBMD (B-BBMD)
 BACnet Router (B-RTR) Supports BACnet Foreign Device Registration (FDR) Supports BACnet interoperability with and between BACnet IP and BACnet MS/TP



17.3 HMI



EQT3-10" (optional)



EQT3-4" (standard)











EQT3-7" (optional)



17.4 Options

- Dampers; Damper Actuators • Filter; Air Pressure Switch
- Coils, Inlet/Outlet Immersion Temperature Sensor, Before/After Duct Type Temperature Sensor, Frost Protection Sensor
- Heat Recovery Components, Before/After Duct Type Temperature Sensor
- Indirect Humidifiers; Before/After Duct Type Temperature and Humidity Sensor • Fans; Frequency Inverters
- Other Control Options; Extract Air Duct Type Temperature Sensor, Outdoor Air Temperature Sensor, Room Temperature Sensor, Smoke Detector, Supply Air Duct Type Temperature Sensor, Supply Air Duct Type Air Pressure Sensor, Exhaust Air Duct Type Temperature Sensor, Exhaust Duct Type Air Pressure Sensor, Man/Auto, VFD/Bypass

17.5 Field Equipments*

Duct Type Temperature Sensor 	Immersion Temperature Sensor 	Frost Protection Sensor 	Duct Type Humidity Sensor 
Outdoor Air Temperature Sensor 	Room Temperature Sensor 	Air Pressure Switch 	Smoke Detector 



*Field equipment models may vary according to the supply status.

17.6 Scenarios

- **Temperature**
 - Supply Air
 - Return Air
 - Outdoor Air
 - Room Temperature
 - Exhaust Air
- **Pressure**
 - Supply Air
 - Return Air
- **Fire Scenario**
- **Frost Protection,**
- **Plate Heat Exchanger,**
- **Heat Wheel,**
- **Mixing Boxes,**
- **Bypass Dampers,**
- **Humidity Scenarios**



18 | Special Applications

18. SPECIAL APPLICATIONS

Carrier 39HQ Airovision air handling unit may offer a response to any type of application thanks to its inherent flexibility. Thus, it is exported to 65 countries in 5 continents and this number is growing each year. It is used in very wide application areas from petrochemical facilities to very specific hygienic applications, from marine type applications to shelter type units, from military facilities to museums where very specific conditions are required. Examples of some special applications are given below.

Air handling units with natural gas modules



Completely stainless steel air handling unit (internal-external panels, profiles, base frame, screws, all internal components etc...)





Atex certified components for Ex-proof applications



Other Special Applications

- Vertical Type Air Handling Units
- L-Type Air Handling Units
- Air Handling Units with Fan Walls
- Air Handling Units with Double and Standby Motors
- Air Handling Units with Walking Platform
- Air Handling Units with External Motors

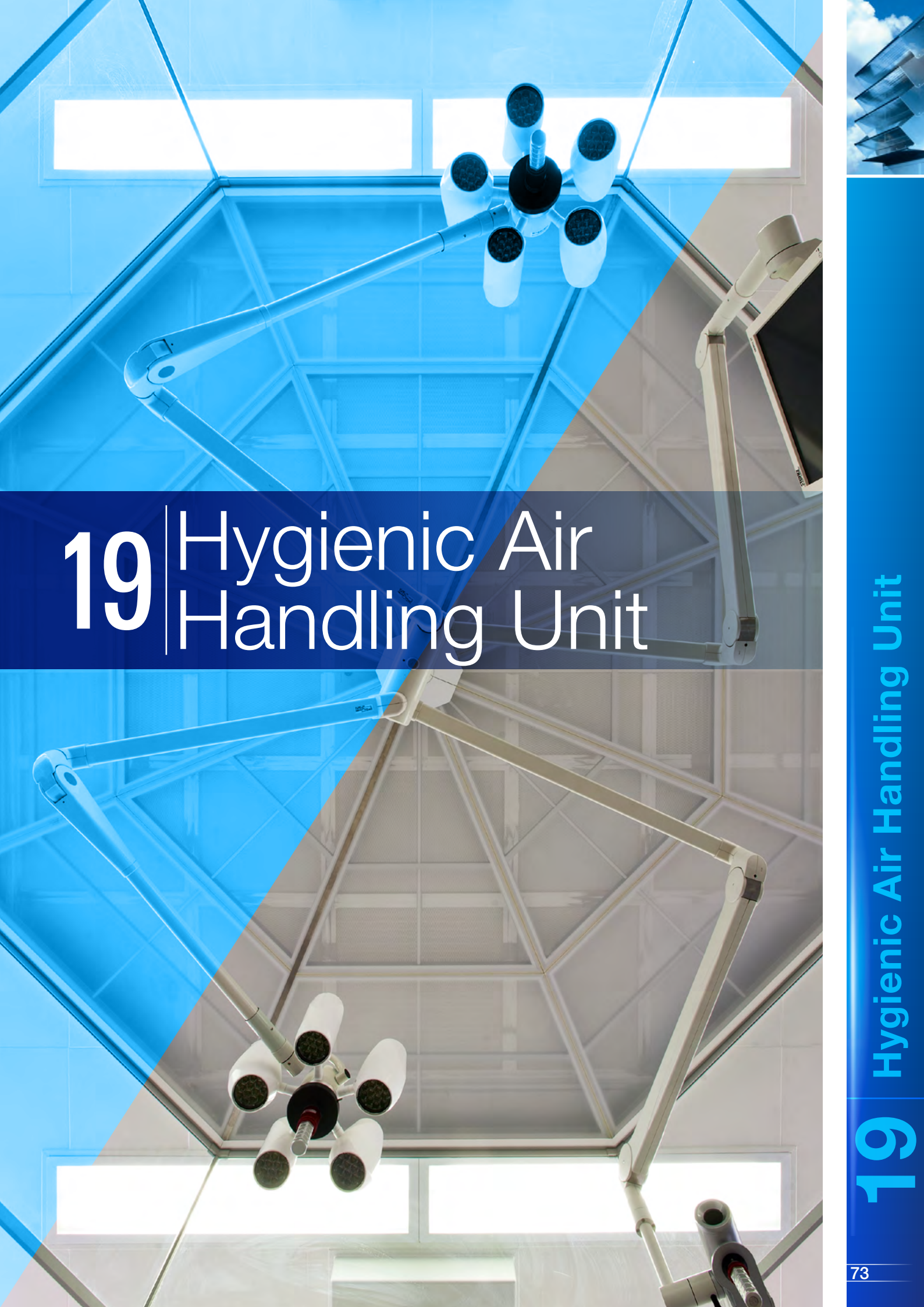

19 | Hygienic Air Handling Unit



19. HYGIENIC AIR HANDLING UNITS

When air handling units are used in hospitals, pharmaceutical plants or special industrial facilities, they shall provide some hygiene standards according to the site that they shall be conditioning the air inside. These standards may vary from one room of the site to another. For example, in a hospital even the operating rooms may have different requirements as per the type of operation to be performed. While many air handling unit manufacturers offer hygienic air handling units as a different series, Carrier branded 39HQ air handling units can be manufactured to meet the hygiene standards by the specifications that can be selected from the selection software as they are fully flexible units.



- Standards
- EN 13053
- DIN 1946/4
- VDI 6022



39HQ hygienic air handling units have been preferred for hundreds of hospital projects up to this day. They also have a hygiene certificate approved by TUV as per EN 13053, DIN 1946/4 and VDI 6022 standards. Although hygiene criteria varies as per the criteria of the relevant sites as we have stated above, we can list the hygiene criteria in general as below.



19.1 Panels:

- Fully removable panels
- Panel / profile connections without drilling the panel body
- L1 casing air leakage class
- F9 filter bypass leakage class
- Dampers inside the air handling unit
- 316 or 304 type 0.8 mm stainless steel interior panels
- 0.8 or 1.25 mm pre-painted external panels with a zinc density of 225 gr/m² and resistant to 500 hours of salty water test
- Door threshold with the same height as floor panel for easy cleaning





19.1 Panels:

- Hygienic ABS corner resistant against corrosion
- Doors of each size and type and with accessories
- Use of special foam gaskets for low leakage on the doors
- All screws are made of stainless steel if indoor panels are selected stainless steel.
- On the exterior air handling units
 - » UV-resistant and water-tight special roof coating
 - » Application of extra silicon compliant with VDI 6022
 - » All screws are made of stainless steel in outside of the air handling unit.
 - » Possibility of louvres and cowls on the air inlets and outlets

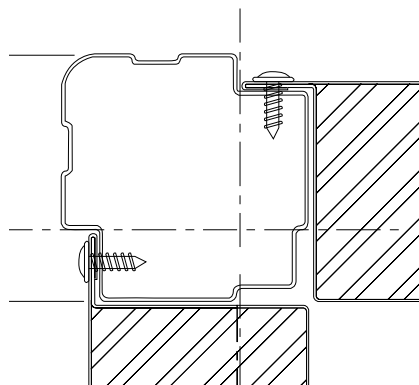

19.2 Coils:

- Maximum surface velocity of 2.5 m/s for cooling coil
- Minimum fin interval: 2 mm for heating coil; 2.5 mm for cooling coil
- Coils pipes coated in copper, fins are aluminium or epoxy coated aluminium, electro-tinned copper or blygold
- Collectors made of copper, coil frame made of stainless steel
- Sloped stainless steel drain pan under the cooling coil and ball type syphon that may be adjusted and installed with different types as per positive and negative pressure to ease the drainage of condensed water
- Installation of bypass plates to prevent air leakage around coils and special plastic gaskets to prevent air leakage from coil pipe outlets to the outside of the unit



19.3 Silencer:

Silencer surfaces shall be water repellent, resistant to wear and smooth



19.4. Fans:

Plug fanlar without belt-drive shall be used, if belt-driven fans shall be used, straight belt types shall be used first and then an additional filter shall be used after the fan.

A door with sight glass shall be provided for access to the fan cell and a light armature with smooth surface shall be used inside the cell. Fan power isolator, inlet cone measuring points shall be used, and drainage plug and inspection hatch shall be used if the fan is belt-driven type.

Fan body, blades and connection elements shall be made of corrosion-resistant material or a special coating shall be applied on them. Informative labels shall be available for each fan inside the fan cells.



19.5. Heat Recovery Cells:

Heat recovery cell types where return air and fresh air are not mixed shall be used (with plate, heat coil or heat pipe). Wheel types shall not be preferred.

Access shall be possible from each side of heat recovery cells for maintenance and service and drain pan and syphon system shall be applied to drain the water condensed under heat recovery systems.

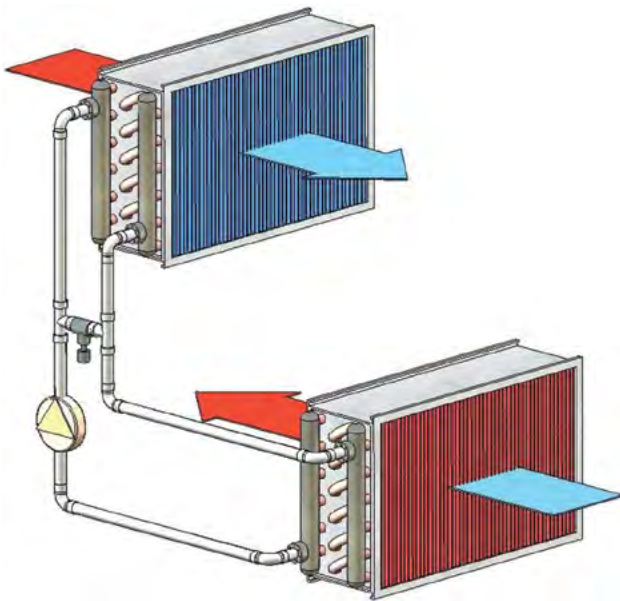

19.6. Filters:

Stainless steel filter frame.

M5 or F7 filtering on fresh air intake side.

F9 filter as the last component on the supply air.

M5 filter on the return air side.

Measuring nipples, pressure gauge and differential pressure switch for measuring filter pressure losses

Informative labels shall be available for each filter inside the filter cells.

A door with inspection glass shall be provided for access to the filter cell and easy replacement of cells and a light armature with smooth surface shall be used inside the cell.



19.7. Humidifiers:

Steam humidifier shall be used for hygienic reasons.

Sloped stainless steel drain pan under the humidifier and ball type syphon that may be adjusted and installed with different types as per positive and negative pressure to ease the drainage of condensed water.

Dimensions of humidifier cell shall be determined by calculating the required absorption distance. Relative humidity shall not exceed 90% at the end of the humidifier cell.

A door with sight glass shall be provided for access to the humidifier cell and a light armature with smooth surface shall be used inside the cell.



19.8. Service and Maintenance:

Cell access door with a min 150 mm sight glass and lighting armature with a smooth surface shall be used for the fan, filter and humidifier cells.

Hinged and hatch doors can be delivered with different sizes and with various accessories for easy of service and safety.



TÜRK
December 2008
THE NORM
DIN
946-4
Supersedes
DIN 1946-4:1999-03 and
DIN 4799:1990-06
ing –
ings and rooms used in the health care
in Gebäuden und Räumen des Gesundheitswesens

DARDI
TS EN 1886
Nisan 2009
ICS 91.140.30

DARDI
6+A1:2011(EN)
Ocak 2012
ICS 91.140.30

20 Certificates

İŞLEME
MANSI
Mechanical
Document comprises 68 pages
Translation by DIN-Sprachendienst.
In case of doubt, the German-language original should be consulted as the authoritative text.
English price group 23
www.din.de
www.beuth.de
1505368

HAVA TAŞIMA
BÖLÜMLERİN
ORANLARI
- Rating and
aynı olup,
Brussels)
ullanım
TSE
ssure drop is
ss the heat
taken into
ethylene
lectric
fence
loor

ie velocity and heat
ements

20. CERTIFICATES

Alarko Carrier San. ve Tic. A. Ş. is the pioneering and leading company of conditioning industry in terms of quality management system in it's Gebze and Dudullu Factories with ISO 9001, ISO 14001, EN 50001, OHSAS 18001 and SA 8000 certificates. Besides these certificates, Carrier 39HQ Airovision air handling units have the product certificates specified below.

CE



EUROVENT

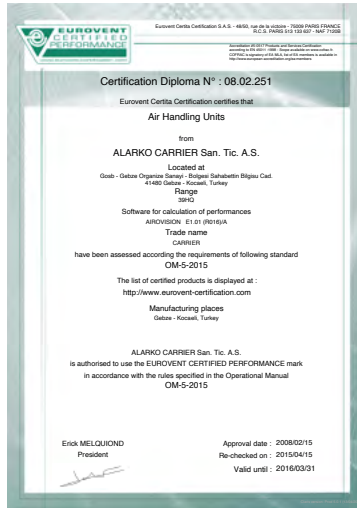

HYGIENE



ATEX (based on component)



TSEK



AHRI (based on component)



EAC





21 | Tests

21. TESTS

Besides the tests required for installation and manufacturing per component (coil leak, fan balancing etc.) for air handling unit, each unit is also tested for final quality control as a finished product in Alarko Carrier Factory.

Other than the standard quality control tests, both product development and performance tests and customer acceptance tests may be performed in great detail.

Alarko Carrier Factory air handling unit test capabilities

Air Handling Unit Tests	Test Unit
Thermal Bridging	Model Box (M)
Thermal Transmission	Model Box (M)
Filter Bypass Leakage	Model Box (M) / Real Unit (RU)
Casing Air Leakage	Model Box (M) / Real Unit (RU)
Mechanical Strength	Model Box (M) / Real Unit (RU)
Measurement of Noise Absorption	Model Box (M)
Acoustic Sound	Model Box (M)
Air Flow	Model Box (M)
Vibration	Model Box (M)





22 | References



22. References

In 65 Countries, In 5 Continents



22.1 Some of Our References Abroad



Mega Ikea, Rostov - Russia



Astana Airport - Kazakhstan



Grand Kremlin Palace, Moscow - Russia



Grand Stade de l'Olympique Lyonnais - France



L'Allianz Riviera ou Grand Stade de Nice - France



Yacht Club de Monaco - France



QAFCO Office Building - Qatar



Workers Hospital & Integrated Health Centre, Mesaieed - Qatar.



Ganjlik Mall, Baku - Azerbaijan



University of Newcastle - Australia



Ichthys Onshore LNG Facility - Australia



L'oreal Factory - Egypt



Ferrero Factory Belsk Duży k. Grójca - Poland



Ministry of Economy, Warsaw - Poland



Africarium Zoo, Wrocław - Poland



Siemens Headquarters, Dubai - UAE



Etisalat Data Center, Fujairah - UAE



Dubai International Airport - UAE



Dubai Opera House, Dubai - UAE



Dubai Fashion Mall, Dubai - UAE



Radisson Blu Hotel - Kuwait



Sheikh Jaber Cultural Center - Kuwait



Burj Al Shaya - Kuwait



Jaguar & Land Rover Factory - UK



Alenia Aermacchi Factory - Italy



Uni-Pharma Factory - Greece



Sulaiman Al Habib Hospital - Saudi Arabia



Dr. Samir Abbas Hospital - UAE



Tawam Hospital - UAE



British American Tobacco Factory - Bangladesh



NMC Specialty Hospital - UAE



King Fahad Hospital - Saudi Arabia



Hirschmann Automotive - Morocco



World Trade Center - Pakistan



Al Houara Resort Hotel - Morocco



Grand Theatre of Rabat - Morocco



Al Kout Mall - Kuwait



Avenues Mall - Kuwait



Abraj Quartier Towers - Qatar



Mall of Qatar - Qatar



Astana Expo - Kazakstan



Sohar Refinery - Oman



Federation Towers - Moscow / Russia



Evolution Towers - Moscow / Russia



Packages Mall - Pakistan



University of South Australia - Australia

22.2 Some of Our References From Turkey



Kartal Courthouse - İstanbul



Tüpraş - Kırıkkale



Air Force Academy - İstanbul



Roketsan - Ankara



Florance Nightingale Hospital - İstanbul



Dünya Göz Hospital, Etiler - İstanbul



Acibadem Hospital, Maslak - İstanbul



Liv Hospital Ulus - İstanbul



Bodrum Airport - Muğla



Buyaka Mall - İstanbul



Medical Park Bahçelievler Hastanesi - İstanbul



International Hospital - İstanbul



Cepa Mall - Ankara



Liv Hospital Ankara



Ankamall - Ankara



Muğla University - Muğla



Amara Dolce Vita - Antalya



Sheraton Hotel - Ankara



Calista Luxury Resort - Antalya



Su Sesi Hotel - Antalya



The Marmara Hotel - Antalya



Karaelmas University - Zonguldak



TOBB University of Economy and Technology - Ankara



Konya Mevlana Cultural Center - Konya



Boshch Diesel Injector Production Facilities - Bursa



Aselsan - Ankara



TAI - Ankara



Turkish Grand National Assembly - Ankara

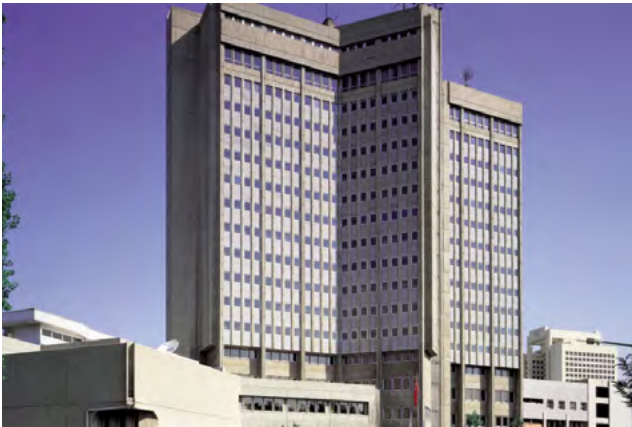

Ministry of Foreign Affairs - Ankara



Antalya Airport - Antalya



Constitutional Court Building - Ankara



Adnan Menderes Airport - Izmir



Archeology and Mosaics Museum - Şanlıurfa



Elite World Business Hotel - İstanbul

İncirlik Air Base	Military Facility	Adana
Turkish Air Forced General Staff Building	Military Facility	Ankara
Adana Subway	Infrastructure	Adana
Enerjisa Tufanbeyli Thermal Power Plant	Infrastructure	Adana
Kalehan Beyhan Dam	Infrastructure	Elazığ
İzmir Courthouse	Courthouse	İzmir
NATA Mall	Mall	Ankara
Tepe Prime Mall	Mall	Ankara
Merter M1 Meydan Mall	Mall	İstanbul
Historia Fatih Mall	Mall	İstanbul
Anse Household Appliances Mall	Mall	Ankara
Kentpark Mall	Mall	Ankara
Demirpark Mall	Mall	Zonguldak
İstinye Park Hillside City Club	Mall	İstanbul
Symbol AVM	Mall	Kocaeli
Garanti Bank District Office	Bank / Finance Institution	İstanbul
Vakıfbank Finance Center	Bank / Finance Institution	İstanbul
Akbank Operation Center	Bank / Finance Institution	Kocaeli
Embassy of Netherlands	Embassy / Consulate	Ankara
Embassy of Canada	Embassy / Consulate	Ankara
Şanlıurfa Government Office	Public Institution	Şanlıurfa
Anadolu Health Center	Hospital / Health Institution	İstanbul
Antalya Public Hospital	Hospital / Health Institution	Antalya
Akdeniz University Faculty of Medicine	Hospital / Health Institution	Antalya
Çukurova Public Hospital	Hospital / Health Institution	Adana
Gaziosmanpaşa Private Hospital	Hospital / Health Institution	İstanbul
Hacettepe University Faculty of Medicine	Hospital / Health Institution	Ankara
Dokuz Eylül University Faculty of Medicine	Hospital / Health Institution	İzmir
Bursa Public Hospital	Hospital / Health Institution	Bursa
Aydın University Faculty of Medicine	Hospital / Health Institution	Aydın
Şişli Kolan Hospital	Hospital / Health Institution	İstanbul
Isparta City Hospital	Hospital / Health Institution	Isparta
Akdeniz University Oncology Hospital	Hospital / Health Institution	Antalya

Bodrum Airport	Airport	Muğla
Kayseri Airport	Airport	Kayseri
Konya Airport	Airport	Konya
Denizli Çardak Airport	Airport	Denizli
Yeşilköy Atatürk Airport	Airport	İstanbul
İstanbul Halkalı Mosque	House of Worship	İstanbul
Fener Greek Patriarchate	House of Worship	İstanbul
Neva Şalom Synagogue	House of Worship	İstanbul
Coca Cola Administrative Buildings	Business Center	İstanbul
MHP Headquarters	Business Center	Ankara
Maslak 42 Offices	Business Center	İstanbul
Sun Plaza	Business Center	İstanbul
Çiftçi Towers	Business Center	İstanbul
İzmir Convention Center	Cultural Center	İzmir
Hacettepe University Convention Center	Cultural Center	Ankara
Darüşşafaka Cultural Center	Cultural Center	İstanbul
Ahmed Adnan Saygun Art Center	Cultural Center	İzmir
Adile Sultan Palace Sakıp Sabancı Kandilli Educational and Cultural Center	Cultural Center	İstanbul
Zorlu AVM Apple Store	Store / Office / Market	İstanbul
İnkilap Bookstore	Store / Office / Market	İstanbul
Hakkasan Restaurant	Store / Office / Market	İstanbul
Şanlıurfa Museum of Archaeology	Museum	Şanlıurfa
Çanakkale Museum of Troy	Museum	Çanakkale
Japanese Anatolian Archaeology Museum	Museum	Kırşehir
Koç Private High School	School / Private Teaching Institution	İstanbul
Dokuz Eylül University	School / Private Teaching Institution	İzmir
İzmir Institute of Advance Technology	School / Private Teaching Institution	İzmir
Ankara University	School / Private Teaching Institution	Ankara
Hacettepe University	School / Private Teaching Institution	Ankara
TOBB University of Economy and Technology	School / Private Teaching Institution	Ankara
Celal Bayar University	School / Private Teaching Institution	Manisa
Akdeniz University	School / Private Teaching Institution	Antalya
Hacettepe University	School / Private Teaching Institution	Ankara

TBF Basketball Arena	Sports Facility	Ankara
Akdeniz University Tribune	Sports Facility	Antalya
Erzurum Ski Center	Sports Facility	Erzurum
Hacettepe University Sports Hall	Sports Facility	Ankara
Fenerbahçe Spor Kulübü Şükrü Saraçoğlu Stadium	Sports Facility	İstanbul
Arçelik	Production Plant	İstanbul
Coca Cola	Production Plant	İzmir
Goodyear Tyres Türk A. Ş.	Production Plant	Sakarya
JTI Tobacco Plant	Production Plant	İzmir
Petlas Tire Plant	Production Plant	Kırşehir
Vestel Elektronik	Production Plant	Manisa
Hugo Boss	Production Plant	İzmir
Bayer Türk Kimya San. Ltd. Şti.	Production Plant	İstanbul
British American Tobacco	Production Plant	İzmir
Mercedes Benz Türk A. Ş.	Production Plant	İstanbul
Toyota Plant	Production Plant	Sakarya
Altınmarka Gıda Sanayi ve Ticaret A.Ş.	Production Plant	İstanbul
Koroza Packaging Plant	Production Plant	Tekirdağ
Club Alibey Hotel	Hotel	Antalya
Crowne Plaza Hotel	Hotel	Ankara
Hillside Beach Club	Hotel	Antalya
Mersin Hilton Hotel	Hotel	Mersin
Xanadu Resort Hotel	Hotel	Muğla
Miracle De Luxe Resort	Hotel	Antalya
Crystal Palace Resort Hotel & Spa	Hotel	Antalya
Bursa Historical Çelik Palas Hotel	Hotel	Bursa
World of Wonders Kiriş Resort	Hotel	Antalya
Dedeman Hotel	Hotel	Zonguldak
Grand Tarabya Hotel	Hotel	İstanbul
Rixos Hotel	Hotel	Muğla
Hotel Les Ottomans	Hotel	İstanbul
Güral Premier Hotel	Hotel	Antalya
Bodrum Kanyon Ranch Holiday Village	Hotel	Muğla

AIR HANDLING UNIT TECHNICAL SPECIFICATIONS

Section 1: General

1.1 Scope:

These specifications determine the technical features, minimum performance and quality standards of the air handling unit and its components specified for the project.

1.2 Quality and Assurance

The configurations of the air handling units shall be in accordance with the project; the manufacturer will guarantee that they have provided the correct configurations.

The design, production and tests of the air handling units shall be done in a factory that is ISO 9001, ISO 14001, ISO 50001, ISO 27001, OHSAS 18001 and SA 8000 certified. The air handling units shall have CE, TSEK, EAC and Eurovent certificates. The air handling units shall be delivered after all quality tests are completed at the factory.

The Eurovent energy class and SFP (specific fan power) values shall be specified on the air handling unit selection report.

There will be a label on the air handling unit showing the Eurovent energy class.

On request the manufacturer must be able to produce air handling units in accordance with 1253/2014 Ecodesign European Regulations on Ventilation Units and must be able to provide product labels and selection reports along with documents that support this.

All of the cables and cable ducts to be used in the air handling unit must not produce toxic gases when exposed to flame for hygienic and safety reasons and must be low smoke density and fire retardant halogen-free type cables and cable ducts. Cabling shall be laid down on the external surface of the air handling units, as much as possible. For cabling that shall be laid down internally, all cables shall be placed inside a cable conduit. The cable conduit compatible to union radius shall be selected and unions shall tighten the cable duct without any gaps.

The enclosure of the air handling unit shall be fitted with IP68 protection class unions for all cable inputs and outputs.

The air handling units shall be in accordance with the EN 13053 (Ventilation for buildings - Air handling units - Rating and performance for units, components and sections) standard.

1.3 Delivery

The manufacturer will deliver the air handling unit's start-up, operation and maintenance manual with the unit. All warning labels for information and safety as required by national standards shall be on the air handling units.

All units delivered by the manufacturer shall be covered with protective coating to protect the units against outdoor conditions during transport and until the units are started up.

1.4 Installation and Start Up

The air handling units that shall be delivered from the manufacturer in different cells will be connected from inside the air handling unit with the delivered connection parts (galvanized strips and gaskets) at the site to make sure they are completely sealed. Connections made from outside the air handling units are not acceptable.

The air handling units shall be operated once the air ducts are cleaned, the filters are attached, the housings are oiled, the drainage siphon is attached according to the user manual, the piping connections are made and tested for leaks, the belts are aligned (if any), the voltage is adjusted and all transport supports are removed.

Section 2: Technical Specifications

2.1 Casing

The air handling unit model box mechanical performance classes shall have the following features at a minimum according to EN 1886.

Casing air leakage	:	L1
Thermal transmittance	:	T2
Thermal bridging	:	TB2
Mechanical strength	:	D1
Filter bypass leakage	:	F9

On requested the manufacturer shall declare the results of a test they have had done by an independent test company according to the EN 1886 standard for the model box and real unit of the air handling unit.

The casing air leakage classes for the real unit will be specified separately as -400 Pa and +400 Pa for the casing on the air handling unit selection report and they shall be L1 class.

The air handling unit casing will be durable to 2.500 Pa operation pressure and compatible for use in outdoor temperatures between - 40 °C and + 55 °C.

The unit shall have a modular structure to fulfill the requested width, length and height.

The panels shall be installed so that the unit carcass (other than the bottom panel) can be detached from the outside and access shall be easy to service in case of malfunction and maintenance. Drilling holes in the panel's insulated sections to install the panels to the unit carcass shall not be allowed.

The unit carcass shall be comprised of clamped profiles and ABS corner parts manufactured from 1 mm thick polyester powder painted galvanized steel material. Unpainted side profiles are not acceptable.

The unit profile, panels and base frames shall be made of the same metal to prevent the galvanic corrosion caused by the contact of two different metals. Profiles manufactured from aluminum are not acceptable. The screw holes of the profiles shall be pre-drilled and the profile paint (to increase corrosion resistance in the notched parts) shall have been applied later both inside and outside the sider profile. The zinc density in the galvanized steel material on the profiles shall be at least 225 gr/m² to provide sufficient corrosion resistance.

All of the outer panels and doors on the unit shall have double skin with 60 mm thickness.

The panel outer sheet metal shall be folded over the inner sheet metal to form a structure that is durable to water and steam leakage. The folded structure shall also prevent any sharp edges to reduce the risk of injury during installation and maintenance. The unit base shall be completely flat therefore allowing all debris to be swept out through the doors without any obstructions.

The panel inner sheet metal shall be at least 0.8 mm thick galvanized steel material. The zinc density in the galvanized steel material on the inner sheet metal shall be at least 160 gr/m² to provide sufficient corrosion resistance. Optionally, the inner panels may be supplied manufactured from Polyurethane - Polyamide (Pur-Pa) painted and 225 gr/m² zinc density galvanized steel sheet metal. Optionally the inner panels may be supplied from material manufactured with 304 or 316 class stainless steel sheet metal. If the inner panels are selected from stainless steel sheet metal all of the screws used in the units (including consumable materials screws) must be stainless steel to prevent galvanic corrosion. The panel outer sheet metal must be at least 0,8 mm thick and painted on galvanized steel with Polyurethane - Polyamide (Pur-Pa) paint. The zinc density in the galvanized steel material on the outer sheet metal shall be at least 225 gr/m² to provide sufficient corrosion resistance.

The panels must comply with the EN 1886 standard D1 mechanical strength class to be durable in operation at ± 2.500 Pa pressure without permanent deformation and have the feature of being durable against TEMPORARY deformation at ± 1.000 Pa under < 1 mm/m.

All inner-outer panel sheet metals and profiles to be used in the air handling units shall be resistant to the 500 hour salt spray test according to ASTM B117.

The doors shall be the same thickness as the casing and coil panels to provide homogenous casing performance in terms of technical features.

Foam type gaskets shall be used on the doors. Glued gaskets are not allowed due to hygienic reasons in the doors. Doors' gaskets shall be tested and certified in accordance with EN ISO 846.

There will be a base frame manufactured from polyester powder painted galvanized steel 2 mm thick under the unit to prevent the unit bottom surface from coming into contact with the surface it is placed on and to provide the necessary casing strength. The zinc density in the base frame shall be at least 225 gr/m² to provide sufficient corrosion resistance. The base frame may be 62 mm or 160 mm in height depending on whether a siphon is used and the resistance needed. On the base frame there shall be holes to place the lifting bars to be used for lifting and transporting the units. The lifting bars for lifting and transporting the units shall be provided by the producer free of charge and delivery along with the units. The air handling unit base frame shall have enclosed sections where the unit is to be carried by therefore reducing the risk of deformation of the base plate during lifting and delivery.

60 mm thick glass wool insulation material in A1 fire class with maximum 0.035 W/mK thermal conductivity coefficient shall be used on the ceiling-side panels and doors, other than the bottom panel. Optionally, rock wool insulation materials in A1 fire class with 0.035 W/mK thermal conductivity coefficient can be used. The panel sizes shall be supported with IPN (isophenic) panels to increase panel durability. The bottom panel insulation shall be IPN (isophenic) material to provide the necessary durability so that the unit panel can be walked on, the weight of the components is endured and the necessary durability in the operation of the fan is provided.

In order to achieve smoothness in the ceiling and side panels no screws shall be used in the unit on the profile panel joints.

Sealing strips shall be used on the joints among the profiles to seal the unit on the outer casing.

The heads of screws used on the outer surface of the units that shall operate outdoors must be painted the same color as the unit surface.

The units that will operate outdoors must have the following features.

- They must be coated with a roof coating materials that is UV and water resistant.
- Silicone must be applied to the panel's corners on the outer surface to increase resistance to air and water leakage.
- The screws that are to be used on the outer panels must be a dacromet type that has high corrosion resistance and must be installed with plastic washers.

All the holes for installing any cables and measuring devices on the air handling unit must be drilled at the producer in advance and must be air proof.

Optionally, the door and at least 160 mm width sight glasses on the filter, humidifier, mixture and fan cells on the unit may be supplied. The door types must be hinged or hatch doors and the L or T type opening mechanisms they hold may have special locks or keys. The sight glasses that shall be assembled on the doors shall be double skinned with 2,500 hours UV resistance (there will be glass on the inside and outside).

Optionally, one detachable light armature that operates with 40 W power and 220 Volts can be supplied in the unit cells. The cabling between the light armature and the switch must be done by the manufacturer.

Silicone shall be applied to around sight glasses to both the inner and outer panel of the units in all indoor and outdoor units that have sight glass for sealing purposes.

The devices that are used for gauging pressure shall be placed in a plastic measurement console (depending on the measuring device model) and the appearance of measuring device pipes will be reduced to a minimum. The manometers shall be placed on the outer panel surface protruding out not obstructing the leakage class of the casing performance without drilling a hole in the unit casing.

Optionally, a palette will be placed under the unit base frame to be delivered from the manufacturer.

All plastic parts which are in contact directly with air inside the air handling units like silicone, sight glass, damper plastic parts, coil's pipe outlet surroundings sealing, door gaskets, anti-vibration mounts etc... shall be tested in accordance with EN ISO 846 standard (Plastics - Evaluation of the Action of Microorganisms) and documented with a certificate obtained from an independent testing organization.

In order to avoid conflicts in the mechanical installation of the building, the 3D drawings of the air handling unit should be taken from the selection program in the revit format.

2.2 Mixing Cell and Dampers

The frames and blades of the control dampers to be used in the air handling units shall be manufactured aluminum material and they shall be aerodynamically designed. The damper will have minimum Class 2 blade leakage class according to the EN 1751 standard and this class must be documented with a certificate obtained from an independent testing organization.

Gaskets shall be used on the blade tips and frames to seal the damper blades.

The damper blade shafts shall be connected to each other with a joint drive system that will provide different position settings for the blades and prevent different movement..

The dampers may be supplied as parallel blade or opposite blade as an option.

Optionally the dampers may be placed inside or outside of the unit.

If the motor connection for the dampers placed inside the units is to be done at the site and not at the factory, sufficient space to install the motor easily shall be left inside the unit.

Air velocity on the dampers (other than circulation and bypass dampers) should not exceed 8 m/s according to EN 13053 standard. The dampers' flexibles in the inlet/outlet and mixing cells must be manufactured from M1 fire class polyester materials according to the CSTB standard.

Optionally the dampers may be supplied in painted form.

Damper actuator shall be spring return type.

2.3 Filter

Optionally the filters may be installed in the air handling unit either by side withdrawal or front withdrawal.

A door shall be used for filter replacement on side withdrawal filters. Empty cell shall be used just after filter cell for filter replacement on front withdrawal filters.

Filters shall not be installed immediately downstream of a wet cells such as cooling coils or humidifiers.

The filter efficiency has been determined according to the EN 779 standard and the efficiency of the filters used in the unit shall be certified for this standard.

G4 class panel filters shall be used on the exhaust side of units with heat recovery.

The filter pressure drops shall be taken as the average of clean and dirty values.

Galvanized steel bypass sheet metal shall be used to prevent air bypass between the filter frame and the unit inner panels in the assembling to the filter inside the unit.

The filters shall be installed with gaskets and tightening apparatus according to the filter class that will hold them on the part/profiles. Sufficient gaps shall be left between the filters to accommodate measuring hose installation in combined filters (ex. G4+F7).

Optionally the filter frames and bypass sheet metal can be supplied as stainless steel.

The panel filters shall be metal framed not cartridge framed. (because cartridge framed panel filters can soften and deform over time due to water and moisture and therefore easily detach from the filter and get swept away by air flows)

Optionally two measuring nipples for each filter panel may be supplied.

Optionally one assembled manometer for each filter may be supplied.

2.4 Fan Section

The fans may optionally be plug or double inlet centrifugal fan types with belt pulleys.

The plug fans must have an AC or DC motor. Plug fans with AC motors must a minimum IE3 or IE4 class efficiency and DC motor fans must be control integrated (EC).

2.4.1 General

In order to absorb the vibrations when fans are operating, anti-vibration mounts shall be used under the fan basement.

Z type profiles shall be installed on the fan base to be used only while transporting to protect the fans and these profiles shall be removed before start-up the fans at the site.

There shall be warning labels on the outside of the fan cell and information labels inside the fan cell.

When manufacturers are selecting fans they will take into account the pressure drops resulting from the system effect and will declare system effect pressure drops on their selection reports.

The values for sound level at the fan inlets and outlets (dB type) measured at between 63-8.000 Hz octave strips must not be over the requested values.

Standard fan motors shall be a type that operates with 380V/3Ph/50Hz electricity supply.

All 3 phase motors shall be at $\pm 10\%$ voltage use range.

Fan efficiency shall be at least 70%.

The motors shall be completely closed. The motor protection class shall be: IP55, operation type: S1 (constant operation), insulation class: F (105 K) and heat increase class: B (80 K).

The motors shall be direct or star delta starting feature depending on power.

2.4.2 Centrifugal Fans

The fan outlet velocity of centrifugal fans shall not exceed 14 m/s.

The flexible connections shall be manufactured from polyester material in M1 fire class according to the CSTB standard.

The belt driven centrifugal fans shall be installed in the unit after completing all electrical, circuit control, belt pulley alignment, vibration, belt tension and balancing tests at factory.

The ball bearings of the centrifugal fans shall have the operation life in the minimum limit working conditions allowed (L10, 20,000 hours; L50, 100,000 hours).

The motor shall have at least 20% more power than the fan shaft power.

If there is a filter, sound attenuator, etc. section after the centrifugal fan, there shall be a diffuser made of galvanized sheet metal to distribute the air smoothly.

The fan motor must be statically and dynamically balanced in G6.3 class according to VDI 2060 and ISO 1940-1.

In variable air flow units the motor shall have PTC protection thermistor suitable for frequency inverter use.

2.4.3 Plug Fans

Plug fan shall be supplied by the fan supplier with fan, motor and inlet cones for the vibration and balancing sensitivity and shall be installed inside the unit. Since the fan manufacturer procuring the fan and motor from different suppliers and installing them in the unit at the factory may cause quality issues in terms of fan balancing and vibration this will not be allowed.

The dynamic balance of the plug fans shall be at G2.5 level according to ISO 1940-1 standard.

The fan shall have a PTC motor protection thermistor suitable for motor frequency inverter use.

Optionally the following options may be provided with the fan:

Drain plug, inspection hatch, inlet cone measuring points, wire mesh, drive guard, fan inlet guard, epoxy painted fan, M0 fire class fan flexible connection, frequency inverter, fan emergency stop button and fan isolator switch.

2.5 Coils

2.5.1 Heating Coils

The heating coils shall provide the requested values for water inlet/outlet temperatures, air inlet/outlet temperatures and pressure drops of air/water sides. The capacity accuracy for the coils shall be confirmed with the selection program.

The face velocity of the coil shall not exceed 3.8 m/s.

Copper pipes according to the features specified in ASTM B68M and EN 12735 shall be used in the heating coils. The copper pipes shall be mechanically expanded for conducting heat to aluminum fins.

The coil frames shall be manufactured from galvanized steel material. Optionally the frames may be manufactured from stainless steel.

The header shall be manufactured from steel materials and painted with electrostatic spray applied epoxy based wet paint. Optionally the headers may be manufactured from copper material.

Bypass sheet metal shall be used to cover the section between the unit inner surfaces and the coil frame to prevent air bypass around the heating coils.

The coils shall be opposite flow and the water inlets shall be from bottom and outlets shall be from top.

Gaskets shall be used to seal the pipe inlets and outlets to the air handling unit.

The pipe connection on the coils shall be threaded type. Optionally they can be supplied with flange and opposite flange.

The heating coils shall be able to operate between at 4-16 bar coil pressure. Coils shall be tested after production in a pool of water with 34 bar pressure.

As a standard there shall be air vents on the coils and a drain plug to empty the water at the bottom.

The pressure drop on the water side of the heating coil shall not exceed 20 kPa.

There shall be an enclosed empty cell at least 320 mm width between the heating and cooling coils on units with both heating and cooling coils in terms being able to provide serviceability.

Optionally they can be supplied with measuring nipples and a frost thermostat.

2.5.2 Cooling Coils

The cooling coils shall provide the requested values for water inlet/outlet temperatures, air inlet/outlet temperatures and pressure drops of air/water sides. The capacity accuracy for the coils shall be confirmed with the selection program.

The face velocity of the coil shall not exceed 3.2 m/s.

Copper pipes according to the features specified in ASTM B68M and EN 12735 shall be used in the cooling coils.

The copper pipes shall be mechanically expanded for conducting heat to aluminum fins.

When the air velocity is more than 2.5 m/s, a droplet eliminator shall be used after the cooling coil to prevent water carry over. The eliminators shall be manufactured from polypropylene material resistant to 120 °C.

The coil frames shall be manufactured from galvanized steel material. Optionally the frames may be manufactured from stainless steel.

The header shall be manufactured from steel materials and painted with electrostatic spray applied epoxy based wet paint. Optionally the headers may be manufactured from copper material.

Bypass sheet metal shall be used to cover the section between the unit inner surfaces and the coil frame to prevent air bypass around the cooling coils.

The coils shall be opposite flow and the water inlets shall be from bottom and outlets shall be from top.

Gaskets shall be used to seal the pipe inlets and outlets to the air handling unit.

The pipe connection on the coils shall be threaded type. Optionally they can be supplied with flange and opposite flange.

The cooling coils shall be able to operate between at 4-16 bar coil pressure. Coils shall be tested after production in a pool of water with 34 bar pressure.

There shall be sloped drain pan with bottom insulation made of stainless steel sheet metal under the cooling coil that completely encloses cooling coil including eliminator section. The air handling unit's 60 mm insulated double skinned panel shall also be used in the bottom panel of the cooling coil to meet the unit's endurance, thermal performance and thermal bridging requirements. Designs in which the drain pan is used in place of the unit's bottom panel are not acceptable. A siphon that can form an air tight water trap and constantly make sure that the condensed water is drained shall be supplied with the unit. The siphon that is provided must be capable of adapting to the negative or positive pressure operation conditions in the coil cell and must be a siphon with a ball.

As a standard there shall be air vents on the coils and a drain plug to empty the water at the bottom.

The pressure drop on the water side of the cooling coil shall not exceed 40 kPa.

Wet condition shall be taken into account when calculating the air side pressure drop in cooling coils.

There shall be an enclosed empty cell at least 320 mm width between the heating and cooling coils on units with both heating and cooling coils in terms being able to provide serviceability.

Optionally they can be supplied with measuring nipples and a frost thermostat.

2.5.3 DX Coil

DX coils shall provide the requested values for refrigerant evaporation temperature, air inlet/outlet temperatures and air side pressure drops. The capacity accuracy for the coils shall be confirmed with the selection program.

The face velocity of the coil shall not exceed 3.2 m/s.

Copper pipes according to the features specified in ASTM B68M and EN 12735 shall be used in the DX coils. The copper pipes shall be mechanically expanded for conducting heat to aluminum fins.

When the air velocity is more than 2.5 m/s, a droplet eliminator shall be used after the DX coil to prevent water carry over. The eliminators shall be manufactured from polypropylene material resistant to 120 °C.

The coil frames shall be manufactured from galvanized steel material. Optionally the frames may be manufactured from stainless steel.

The headers shall be manufactured from copper material.

Bypass sheet metal shall be used to cover the section between the unit inner surfaces and the coil frame to prevent air bypass around the DX coils.

The inlet of the coils shall be equipped with distributors at the top and the outlet shall be at the bottom with a suction connection. The delivery shall be made with the DX coil inlets and outlets (so that there shall be no need to make any holes in the unit casing at the site) brought outside of the units.

Gaskets shall be used to make sure the pipe inlet and outlets of the coils to the outside of the air handling unit are sealed.

When choosing DX coils at least 20 % safety factor shall be taken into account.

DX coils' pressure shall be convenient up to 21 bar at operating and up to 34 bar at test conditions of R134A and R407C refrigerants.

DX coils' pressure shall be convenient up to 32 bar at operating and up to 48 bar at test conditions of R410A refrigerants. .

Flat copper pipes shall be used in DX coils using R134A and R407C refrigerants. Grooved copper pipes shall be used in DX coils using R410A refrigerant.

Wet condition shall be taken into account when calculating the air side pressure drop in DX coils.

There shall be sloped drain pan with bottom insulation made of stainless steel sheet metal under the cooling coil that completely encloses DX coil including eliminator section. The air handling unit's 60 mm insulated double skinned panel shall also be used in the bottom panel of the DX coil to meet the unit's endurance, thermal performance and thermal bridging requirements. Designs in which the drain pan is used in place of the unit's bottom panel are not acceptable. A siphon that can form an air tight water trap and constantly make sure that the condensed water is drained shall be supplied with the unit. The siphon that is provided must be capable of adapting to the negative or positive pressure operation conditions in the coil cell and must be a siphon with a ball. Optionally they may be supplied with measuring nipples and a frost thermostat..

2.6 Electrical Heater

The electrical heater shall be evenly distributed in the air handling unit casing and have multi stage control. The casing shall be manufactured from C4 corrosion class Aluzinc coated steel (AZ 185), the heater shall be manufactured from stainless steel. The electrical heater protection class shall be IP43 as a standard. Optionally the protection class can be supplied as IP55 or IP65 class.

As a standard the electrical heater shall have two temperature limit switches, one with automatic (75 °C) and one with manual reset (120 °C). Optionally it can be supplied with an air flow switch.

To provide easy electrical connection at the site the cable connection holes shall be pre-drilled on the panel and the hatch door shall be provided as a standard. The terminal box, which contains the details of the electrical cabling, shall be installed on the air handling unit.

2.7 Humidifiers

2.7.1 Water Spray Humidifier

A cell shall be placed in the air handling unit structure at a suitable length for the humidifying capacity for the water spray humidifiers. The humidifier shall be an evaporative type and shall be installed in the cell at the factory. The media shall be manufactured from a material made of cellulose layer with high suction power. The humidifier shall have enough submersible pumps according to the number of splitters and flow requirement. The pump(s) shall send water onto the media material through distribution pipes. There shall be a drain pan made of stainless steel sheet metal under the humidifier cell and a drainage plug to discharge water. The air handling unit's 60 mm insulated double skinned panel shall also be used in the bottom panel of the humidifier cell to meet the unit's endurance, thermal performance and thermal bridging requirements. Designs in which the drain pan is used in place of the unit bottom panel are not acceptable. Optionally a droplet eliminator may be used to prevent water carry over from the humidifier cell.

2.7.2 Steam Humidifier

The steam humidifier cell shall be a sufficient length to provide the required capacity conditions and the absorption distance needed for the humidifying process.

The multi distribution nozzles of steam humidifiers will be installed in the unit and the steam generators shall be in the unit but not installed for delivery.

There shall be a drain pan made of stainless steel sheet metal under the humidifier cell and a drainage plug to discharge water. The air handling unit's 60 mm insulated double skinned panel shall also be used in the bottom panel of the humidifier cell to meet the unit's endurance, thermal performance and thermal bridging requirements. Designs in which the drain pan is used in place of the unit bottom panel are not acceptable.

2.8 Heat Recovery Unit

2.8.1 Plate Heat Recovery Unit

The plate heat recovery unit calculations shall be done according to the VDI 2071 standard.

The plate heat recovery unit shall be procured from a Eurovent certified supplier.

When the exhaust and supply air flow that go through a heat recovery unit that operates with a cross flow logic are equal, the total heat recovery efficiency in winter operation shall be at least 50%.

The accuracy of the heat recovery capacity shall be verified with the selection program.

The pressure drops of the heat recovery unit on the exhaust and supply air sides shall not exceed 250 Pa.

Optionally a bypass damper may be used in the heat recovery unit to control air flow and operate in free cooling mode if needed. Optionally the unit may be supplied with a droplet eliminator placed in the exhaust air side.

There shall be a drain pan covering the bottom of the heat recovery unit and a drainage plug on both the exhaust and the supply side to discharge accumulated water.

The heat recovery unit shall have service doors on all four sides with easy access to the inside both on the exhaust and the blower side.

2.8.2 Wheel Heat Recovery Unit

The wheel heat recovery unit calculations shall be done according to the VDI 2071 standard.

The wheel heat recovery unit shall be procured from a Eurovent certified supplier.

When the exhaust and supply air flow that go through the wheel are equal, the sensible and latent heat recovery efficiency in both winter and summer operation shall be at least 60%.

The accuracy of the heat recovery capacity shall be verified with the selection program. The air velocity of the wheel on the exhaust and supply air sides shall not exceed 4 m/s and the pressure drops shall not exceed 250 Pa.

The wheel shall be speed controlled and the speed control device shall be provided along with the unit.

The wheel inverter shall be CE compliant and IP54 protection class. The wheel controller shall control the acceleration and slowing down of the AC motor continuously.

The rotor drive shall be made with a belt pulley system.

Depending on the project requirement the heat recovery wheel frames may be galvanized steel, aluminum or stainless steel.

The sections that comprise the wheel shall be delivered assembled and in a single piece at manufacturer.

The heat recovery wheel (on the condition of the selection being made suitably) may be placed in the air handling unit or between the unit cells.

The cabling and assembly of the sensor that controls the wheel speed shall be done by the manufacturer.

In order to have access to the motor in the section where the wheel motor is located, there shall be a inspection hatch that is provided as a standard.

The exhaust fans shall draw air over the heat recovery unit to reduce the rate at which exhaust mixes in with fresh air. Configurations in which the exhaust fans push air into the heat recovery unit are not acceptable.

The heat recovery unit shall have service doors on all four sides so that the exhaust and supply sections and the wheel fan can be accessed easily.

Optionally the purging sector can be supplied with heat recovery unit. A portion of the fresh air can be directed to the exhaust air thus minimizing the amount of air that passes from the exhaust section to the fresh air section.

Optionally a bypass damper can be used in the heat recovery unit to control air flow and operate in free cooling mode when necessary.

2.8.3 Heat Pipe Type Heat Recovery Unit (Vertical, Horizontal or Horse Shoe Type) (Heat Pipe)

Coils with heat pipes shall provide the requested values for refrigerant evaporation temperature, air inlet/outlet temperatures and air side pressure drops.

The capacity accuracy of the coils shall be verified with the selection program.

The air face velocity in the coils shall not exceed 3.2 m/s.

Copper pipes according to the features specified in ASTM B68M and EN 12735 shall be used in the heat pipe coils. The copper pipes shall be mechanically expanded for conducting heat to aluminum fins.

The coil frames shall be manufactured from galvanized steel material.

Bypass sheet metal shall be used to cover the section between the unit inner surfaces and the coil frame to prevent air bypass around the heating coils.

There shall be a drain pan made of stainless steel sheet metal under the heat pipe coils and a drainage plug to discharge water.

In the horseshoe type heat recovery system the coils are placed according to the precooling, cooling coil and preheating principle on the supply air side.

The heat pipe coil supplier must have at least 10 years production experience in this field.

2.8.4 Run Around Heat Recovery Unit

In the air handling unit with a heat recovery system comprised of two coils, one on fresh air and one on exhaust air, shall be used. It shall be designed with the fresh air side and exhaust air side completely separated preventing any air mixture.

The coils shall be manufactured from copper pipe and aluminum fins. The run around coils shall be selected so that the heat recovery efficiency is at least 40%. The capacity accuracy of the coils shall be verified with a selection program. The headers shall be manufactured from steel materials and painted with electrostatic spray applied epoxy based wet paint. Optionally the headers may be manufactured from copper material.

The water-glycol mixture shall be transferred between two coils with a circulation pump. The pump, piping and accessories shall be supplied and assembled at the site by the contractor. The face velocity of the coils shall not exceed 3.2 m/s. When the air velocity is more than 2.5 m/s, a droplet eliminator shall be used after the cooling coil to prevent water carry over. The eliminators shall be manufactured from polypropylene material resistant to 120 °C.

Copper pipes according to the features specified in ASTM B68M and EN 12735 shall be used in the cooling coils. The copper pipes shall be mechanically expanded for conducting heat to aluminum fins.

The coil frames shall be manufactured from galvanized steel material. Optionally the frames may be made of stainless steel.

Bypass sheet metal shall be used to cover the section between the unit inner surfaces and the coil frame to prevent air bypass around the coils.

The coils shall be opposite flow and the water inlets shall be from bottom and outlets shall be from top.

Gaskets shall be used to seal the pipe inlets and outlets to the air handling unit.

The pipe connection on the coils shall be threaded type. Optionally they can be supplied with flange and opposite flange.

The coils shall be able to operate between at 4-16 bar coil pressure. Coils shall be tested after production in a pool of water with 30 bar pressure.

The pressure drop on the water side of the coils shall not exceed 50 kPa.

The wet condition shall be taken into account when calculating the air side pressure drops of coils.

There shall be sloped drain pan with bottom insulation made of stainless steel sheet metal under the cooling coil that completely encloses cooling coil including eliminator section. The air handling unit's 60 mm insulated double skinned panel shall also be used in the bottom panel of the cooling coil to meet the unit's endurance, thermal performance and thermal bridging requirements. Designs in which the drain pan is used in place of the unit bottom panel are not acceptable. A siphon that can form an air tight water

trap and constantly make sure that the condensed water is drained shall be supplied with the unit. The siphon that is provided must be capable of adapting to the negative or positive pressure operation conditions in the coil cell and must be a siphon with a ball.

2.9 Sound Attenuator

The sound attenuator splitters shall be installed inside the unit. The sound attenuation levels shall not be lower than the requested values for each octave band.

The sound attenuator splitters shall be in rectangular prism form designed and produced according to the EN ISO 7235 standard. The sound attenuator splitter gaps and installations shall be in accordance with sound attenuation principles preventing deformation.

The sound attenuation sections shall be made of inorganic, inflammable mineral wool that complies with the DIN 4102 Class A1 flame spreading conditions. This will prevent corrosion even when the velocity is 20 m/s between the splitters. The sound attenuator section pressure drop shall be 50 Pa at the most.

Optionally the surfaces can be perforated plate to increase sound attenuation.

2.10 UVC Lamp

UVC lamp shall be used in the air handling unit to kill very small microorganisms that cannot be held by the filters but can harm human health. After the cooling coils a cell 320 mm or 480 mm long shall be placed for the UVC lamps and a sufficient number of lamps will be installed in the cell at the manufacturer. If the UVC lamp cell cannot be accessed from the front or back cell, a door shall be provided. The electrical supply of the UVC lamp shall be completed at the site by the contractor.

Section 3: Standards

All standards are mentioned on air handling unit's guide specification are listed below with their explanations.

ISO 9001: Quality Management System

ISO 14001: Environmental Management System

ISO 50001: Energy Management System

ISO 27001: Information Security Management

OHSAS 18001: Occupational Health and Safety Management System

SA 8000: Social Accountability International

CE: European Conformity

TSEK: Certificate of Conformity to Turkish Standard Institution Criterion

EAC: EurAsian Conformity Mark

Eurovent: Certifies the performance ratings of air-conditioning and refrigeration products according to European and international standards)

1253/2014: Ecodesign Requirements for Ventilation Units EU Commission Regulation

EN 1886: Ventilation for Buildings – Air Handling Units – Mechanical Performance

EN 13053: Ventilation for buildings - Air handling units - Rating and performance for units, components and sections

EN 779: Particulate air filters for general ventilation - Determination of the filtration performance

EN 12735: Copper and copper alloys - Seamless, round tubes for air conditioning and refrigeration

EN ISO 846: Plastics - Evaluation of the Action of Microorganisms

EN ISO 7235: Acoustics; measurement procedures for ducted silencers; insertion loss, flow noise and total pressure loss

ISO 1940-1: Mechanical vibration -- Balance quality requirements for rotors in a constant (rigid) state -- Part 1: Specification and verification of balance tolerances

EN 1751: Ventilation for buildings. Air terminal devices. Aerodynamic testing of damper and valves

VDI 2060: Characteristics and Recognition of non-linear Vibratory Systems

VDI 2071: Heat Recovery in heating, ventilation and air-conditioning plants

DIN 4102: Fire test to building material

ASTM B68M: American Section of the International Association for Testing Materials: Standard Specification for Seamless Copper Tube (An American Standards Organization)

ASTM B117: American Section of the International Association for Testing Materials: Salt Spray Test (An American Standards Organization)

CSTB: Scientific and Technical Centre for Building) (A French Standards Organization)



United Technologies



Manufacturer reserves the right to change any product specifications without notice.



AHI CARRIER EUROPE

GREECE

AHI CARRIER S.E. EUROPE SINGLE MEMBER S.A.

Headquarters

18, Kifissou Ave.
104 42 - Athens
Tel.: +30 210 6796300

Thessaloniki Branch

5, Ag. Georgiyo str., Cosmos Offices
570 01 - Patriarhiko Pileas Thessaloniki
Tel.: +30 231 3080430

grinfo@ahi-carrier.eu
www.ahi-carrier.gr
www.toshiba-aircon.gr

BULGARIA

AHI CARRIER HVAC BULGARIA EOOD

Trade Center Europe Building 6,
floor 3, office 6
7 Iskarsko Shose Blvd., Sofia 1528
Tel.: +35 929483960
bginfo@ahi-carrier.com
www.ahi-carrier.bg
www.toshiba-aircon.bg

ROMANIA

AHI CARRIER ROMANIA SRL

Intrarea Nestorei 1, Corp B, Et. 5, Sector 4
Cladirea River Plaza, RO-040295 Bucuresti
Tel.: +40 214 050751
roinfo@ahi-carrier.eu
www.ahi-carrier.ro
www.toshiba-aircon.ro