



## PRODUCT SELECTION DATA

### AIR-COOLED SCROLL CHILLERS AND HEAT PUMPS WITH GREENSPEED® INTELLIGENCE



Low environmental impact

High full and part load efficiency

Compact and simple to install

Low refrigerant charge

Superior reliability

## 30RB/30RQ 040R-160R

Cooling capacity 40-160 kW

Heating capacity 40-160 kW

Aquasnap® liquid chillers and heat pumps are the best solution for commercial and industrial applications where installers, engineering and design departments and building owners require reduced installation costs, optimal performances and maximum quality.

- AquaSnap® (30RB-30RQ) is a compact all-in-one package optimised for applications where reduced investment and installation cost (low CapEx) is required.
- The large options panel allows for configurations that suit user requirements.
- The pump and variable-speed fan options with Greenspeed® intelligence Carrier control logic makes it a product optimised for part load applications where a high SEER, SEPR, SCOP or IPLV value is required.

In this configuration AquaSnap® offers a premium part load efficiency to reduce maintenance costs over the lifespan of the chiller. In addition, the sound levels achieved under the part load conditions are particularly low. Besides operating efficiently and quietly, the AquaSnap® range with Greenspeed® intelligence operates from -20 °C up to +46 °C as standard.



\* The availability of sizes and options depends on the country. Please contact your local commercial dealer for more information.



CARRIER participates in the ECP programme for LCP/HP  
Check ongoing validity of certificate:  
[www.eurovent-certification.com](http://www.eurovent-certification.com)

# R-32: THE BEST SOLUTION FOR SCROLL LIQUID CHILLERS AND HEAT PUMPS



Carrier was the first to introduce the R-1234ze HFO with ultra-low GWP in screw chillers, as far back as early 2016. Today, having examined its main properties, Carrier has chosen R-32 refrigerant to replace high-GWP R-410A refrigerant in its Scroll liquid chillers and heat pumps, for its lower environmental impact, high energy efficiency, good availability and ease of use.

R-32 is currently the ideal refrigeration solution for units equipped with Scroll compressors. By using R-32 refrigerants, Carrier has reduced the carbon footprint of its AquaSnap® range of liquid chillers and heat pumps by 80%. This is the result of a much lower GWP and a significant reduction in the system's cooling charge compared to the previous generation that used R-410A.

R-32 is also the right choice economically, reducing the locally imposed tax burden on HFCs based on the CO<sub>2</sub> impact.



## Lower environmental impact (-80% compared to R410A)

- R-32 has zero ozone depletion potential (ODP)
- The Global Warming Potential (GWP) of R-32 is 675, i.e. approximately one third of that of R-410A (PRP 2088)
- The AquaSnap® R-32 cooling charge is reduced by 30% compared to the previous version using R-410A\*
- The carbon footprint of AquaSnap® R-32 is therefore 473 (675 x 0.7), i.e. 80 % lower than the version using R-410A (2088 x 1)

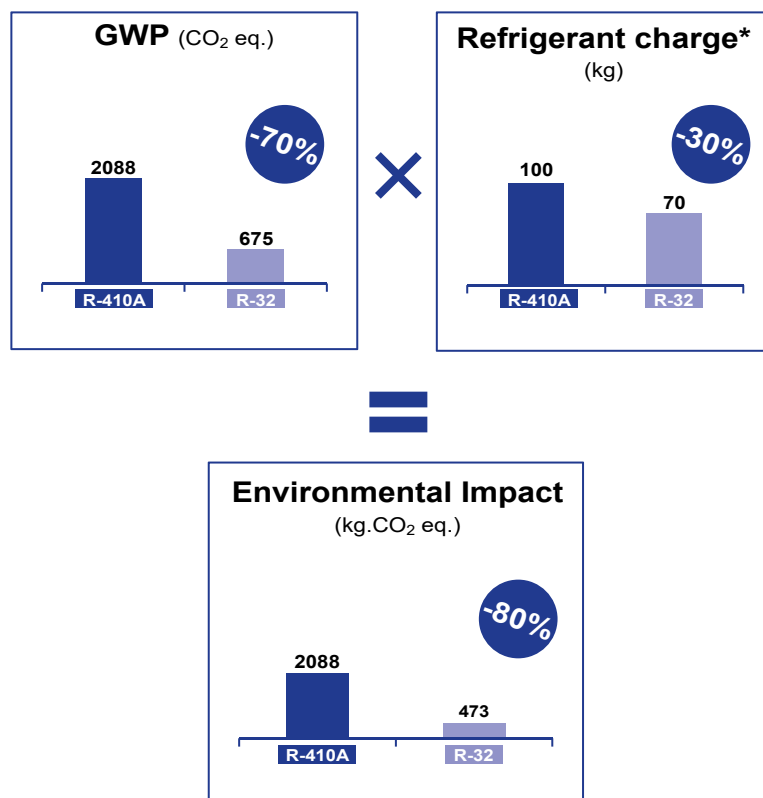

\* Reduced refrigerant charge in Carrier heat pumps thanks to the use of R-32 and a new coil design.

\* The availability of sizes and options depends on the country. Please contact your local commercial dealer for more information.

# R-32: THE BEST SOLUTION FOR SCROLL LIQUID CHILLERS AND HEAT PUMPS



**SEER** up to **+10%**  
**SCOP** up to **+6%**

## High energy efficiency

The seasonal efficiency of AquaSnap® R-32 is higher than that of the previous R-410A version by:

- approximately 10% in cooling mode
- approximately 6% in heating mode

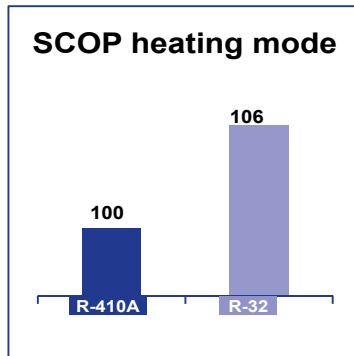
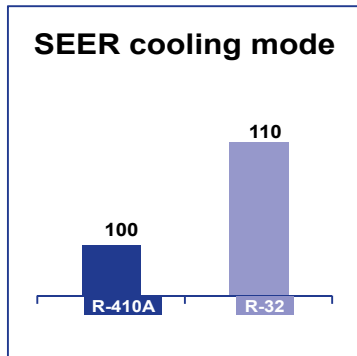

## SIMPLICITY

## Widely available and easy to use

More than 50 million R-32 air conditioning units are in circulation on the global market. While R-32 has been used for some time in residential and commercial air conditioning units, most manufacturers now use R-32 in VRF systems, liquid chillers and heat pumps, which means R-32 is widely available around the world.

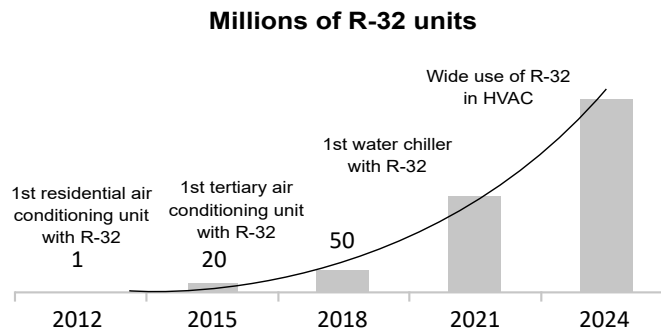

R-32 has been widely available for over 15 years, as it comprises 50% of the composition of R-410A.

R-32 is easy to use: It is a pure refrigerant, therefore it is not necessary to drain the entire circuit in the event of a leak.



## SAFETY

R-32 is an A2L classified refrigerant thanks to its low flammability.

- **No specific safety requirements** for transporting chillers by road or for outdoor installation.
- The service tools must be **certified** for **A2L** refrigerants in accordance with standard ISO 817 or EN378.
- Service technicians **must be qualified for brazing components** on PED 2 fluid units.

\* The availability of sizes and options depends on the country. Please contact your local commercial dealer for more information.

# AQUASNAP® - CUSTOMER BENEFITS

## ■ Outstanding performance

Equipped with variable-speed fans (VSD or EC optional) and optional variable-speed pumps, Carrier's AquaSnap® 30RB/RQ range with Greenspeed® intelligence automatically adjusts the cooling capacity and water flow to perfectly adapt to the building's requirements or load variations. The result is optimum operation at both full load and part load (SEER up to 4.6). The 30RB/RQ offers energy efficiency up to 10% higher than the previous range with the same or a smaller footprint. The range is already fully compliant with the 2021 Ecodesign regulations.



SEER up to **4.6**

## ■ Intelligence and connectivity

The advanced SmartVu™ intelligent control system displays operating parameters in real time, making it intuitive and particularly user-friendly. The AquaSnap® 30RB/RQ range is also characterised by a brand new smart energy monitoring function which provides users with smart data such as electrical energy consumption in real time, supplied cooling and heating energy and instantaneous and average seasonal energy efficiency values. For even greater energy savings, the AquaSnap® 30RB/RQ can be monitored remotely by Carrier experts to further optimise the energy consumption level.



SMART ENERGY  
MONITORING

## ■ Extensive field of application

The AquaSnap® range is suitable for a very wide range of applications from tertiary to industrial processes. The range can operate at outdoor temperatures from -20 °C to +44 °C (Optional 46 °C) and with negative water temperatures (-8 °C). From high-end office buildings and hotels to healthcare facilities, data centers and industrial projects, AquaSnap® 30RB/RQ units meets the most demanding expectations in terms of energy efficiency and savings, whatever the climate or application.



BETWEEN  
**-20 °C**  
and **46 °C**

## ■ Easy installation & maintenance

Thanks to the variable-speed pumps, automatic adjustment of the nominal water flow rate via electronic control and automatic measurement of the unit's energy performance under real conditions, pumping energy consumption is reduced by almost two thirds: These new features guarantee peace of mind for installers and maintenance companies and lower energy bills for users.



Pumping energy  
reduced by  
up to **66%**

\* The availability of sizes and options depends on the country. Please contact your local commercial dealer for more information.

## AQUASNAP® - CUSTOMER BENEFITS

AquaSnap® liquid chillers and heat pumps are designed to meet current and future Ecodesign and F-Gas European regulation requirements in terms of energy efficiency and reduced CO<sub>2</sub> emissions. They use the best technologies available today:

- Reduced refrigerant charge of non-ozone depleting R-32A refrigerant with low GWP
- Scroll compressors
- Greenspeed® variable-speed fans (optional)
- NOVATION™ micro-channel heat exchangers with a new aluminium alloy (30RB)
- Brazed-plate heat exchangers with reduced pressure drops
- Self-regulating microprocessor control with Greenspeed® intelligence
- Colour touch screen with web connectivity options

AquaSnap® can be equipped with a built-in hydraulic module, limiting the installation to conventional operations such as connection of the power supply and the supply and return piping (plug & play), according to the dimensions of the standard unit.

Recommended by Carrier, the AquaSnap® can be equipped with one or two Greenspeed® variable-speed pumps to significantly reduce energy costs linked to pumping (reduction of more than two-thirds), ensure optimum water flow rate control, and improve overall system reliability.



### Very economical operation

- High unit full- and part-load energy efficiency and efficient design of the water side:
  - SEER<sub>12/7°C</sub> up to 4.6 in line with the new Ecodesign 2016/2281 regulations.
  - Multiple scroll compressors equipped with a high-efficiency motor which can exactly match the cooling capacity to the load required
  - Electronic expansion valve enabling operation at a lower condensing pressure and improved use of the evaporator heat exchange surface (superheat control)
  - Condenser with high-efficiency NOVATION™ (30RB) aluminium micro-channel heat exchangers and Greenspeed® variable-speed fans (optional)
  - Low pressure drop brazed plate heat exchangers (< 45 kPa under Eurovent conditions).

- Specific control functions to reduce unit cooling energy use during occupied and unoccupied periods:
  - Internal timer: Switches the chiller on/off and controls operation at a second setpoint
  - Setpoint automatically offset based on the outdoor air temperature or room air temperature (via an option)
  - Floating high pressure (HP) management
  - Variable-speed fan control
  - Cooling demand limitation.

Refer to the control chapter for more information.

- Greenspeed® variable-speed pump to reduce pumping energy consumption by up to two-thirds (option recommended by Carrier):
  - Eliminate energy losses through the water flow rate control valve by electronically setting the nominal water flow rate
  - Save energy during stand-by periods or part-load operation by automatically reducing the water pump speed. The energy consumption of the pump motor varies according to the cube of the speed, so that a reduction in speed of just 40% can reduce energy consumption by 80%
  - Improved unit part-load performance (increased SEER/SCOP value with variable water flow according to standard EN14825).

Refer to the hydraulic option chapter for more information.

- Extra energy savings through multiple options:
  - Carrier drycooler Free cooling mode management
  - Partial heat recovery.
- Reduced maintenance costs:
  - Fast diagnosis of possible incidents and their history via the control
  - Programmable maintenance alert
  - Programmable F-Gas leak monitoring alert

\* The availability of sizes and options depends on the country. Please contact your local commercial dealer for more information.

# AQUASNAP® - CUSTOMER BENEFITS

---

## Low noise level

- Condenser with fixed-speed fans (30RB-30RQ):
  - Optional low-speed and variable-speed fans (700 rpm) and compressor enclosure to reduce full-load noise level by up to -9 dB(A)
  - Low noise 6th generation Flying Bird™ fans, made of a composite material (Carrier patent)
  - Rigid fan installation for reduced noise (Carrier patent).
- Condenser with Greenspeed® variable-speed fans (optional) recommended by Carrier for even quieter operation:
  - Optional factory setting of the fan at low speed, with compressor enclosure to reduce full-load noise level by up to -9 dB(A)
  - Exceptional acoustic signature during part-load operation through smooth fan speed variation.
- Specific control functions or features to reduce noise level during the night or unoccupied periods:
  - Night-time sound control with cooling capacity and fan speed limitation
  - Low-noise scroll compressors with low vibration level
  - The compressor assembly is installed on an independent chassis and supported by flexible anti-vibration mountings
  - Dynamic suction and discharge piping support, minimising vibration transmission (Carrier patent)
  - Acoustic compressor enclosure, reducing radiated noise emissions (optional).

## Easy and fast installation

- Compact design:
  - AquaSnap® units are designed with compact dimensions for easy installation.
  - With a length of approximately 4.8 m for 550 kW and a width of 2.25 m, the units require minimal floor space.
- Integrated hydraulic module (optional):
  - Low or high-pressure water pump (as required)
  - Single or dual pump (as required) with runtime balancing and automatic changeover to the back-up pump if a fault develops

- Integrated variable-speed pumps with automatic adjustment of nominal water flow rate via the electronic control on the user's screen.
- Water filter protects the water pump against circulating debris
- Pressure sensors for direct numerical display of the water flow rate and water pressures
- Thermal insulation and frost protection down to -20 °C, using a heater (optional)
- High-capacity membrane expansion tank (optional).
- Built-in hydraulic module with Greenspeed® variable-speed pump (option recommended by Carrier):
  - Quick and easy electronic setting of the nominal water flow rate when the unit is commissioned, thus eliminating the need to adjust the water flow rate control valve
  - Automatic control of the pump speed based on constant speed, constant pressure difference or constant temperature difference.
- Simplified electrical connections
  - A single power connection point without neutral
  - Main disconnect switch with high trip capacity
  - 24 V control circuit using an integrated transformer.
- Simplified hydraulic connections:
  - Victaulic type couplings on the exchanger;
  - clearly identified and practical reference marks for entering and leaving water connections;
- Fast unit commissioning
  - Systematic factory test before shipment
  - Quick-test function for step-by-step verification of the sensors, electrical components and motors.

## Reduced installation costs

- Optional Greenspeed® variable-speed pump with hydraulic module (option recommended by Carrier)
  - Cut costs relating to the water flow control valve
  - The design of the water system with variable primary flow (VPF) can provide significant installation cost savings compared with traditional constant primary systems with variable secondary circuits; elimination of the secondary distribution pump, etc.
  - Water system design with fan coils fitted with 2-way valves instead of 3-way valves.
- No buffer tank required thanks to Carrier's advanced control algorithm
  - Minimum water loop volume reduced to 2.5 l/kW.

\* The availability of sizes and options depends on the country. Please contact your local commercial dealer for more information.

# AQUASNAP® - CUSTOMER BENEFITS

---

## Environmental responsibility

AquaSnap® liquid chillers with Greenspeed® intelligence (With optional variable-speed fans and pumps) are a boost for green cities and contribute to a sustainable future. Combining a refrigerant charge up to 30% lower, with R-32 refrigerant with a GWP 70% lower than that of the previous version using R410A, and exceptional energy efficiency, this chiller significantly reduces energy consumption while reducing carbon dioxide emissions throughout its life cycle.

- Pumping energy consumption can be reduced by up to 2/3 using Greenspeed® variable-speed pumps
- 40% lower refrigerant charge: The micro-channel technology used for condenser coils optimises heat transfer while minimising the refrigerant volume.
- Sealed refrigerant circuits:
  - Reduction of leaks thanks to the absence of capillary tubes and the use of flare connections
  - verification of pressure transducers and temperature sensors without transferring refrigerant charge;
  - discharge line shut-off valve and liquid line service valve for simplified maintenance
  - Qualified Carrier maintenance personnel to provide refrigerant servicing
  - ISO 14001 production plant

## Superior reliability

- State-of-the-art concept
  - Two independent refrigerant circuits; the second one automatically takes over if the first one develops a fault, maintaining partial cooling in all circumstances
  - All compressor components are easily accessible on site, minimising downtime
  - All-aluminium Novation™ micro-channel heat exchanger (MCHE) (30RB) with higher corrosion resistance than a conventional coil. The all-aluminium construction eliminates the formation of galvanic currents between aluminium and copper which can corrode the coil in saline or corrosive atmospheres
  - V-coil design to protect the coils against hail impact

- Optional Enviro-shield® anti-corrosion coil coating for use in moderately corrosive environments. Coating applied through conversion process which modifies the surface of the aluminium producing a coating that is integral to the coil. Immersion in a bath to ensure 100% coverage. No heat transfer variation, tested for 4000 hours in salt spray per ASTM B117
- Optional Super Enviro-shield® anti-corrosion coil coating for use in extremely corrosive environments. Extremely durable and flexible epoxy polymer coating applied on micro-channel heat exchangers by electro coating process with a final UV protective topcoat. Minimal heat transfer variation, tested for 6000 hours in salt spray per ASTM B117, superior impact resistance per ASTM D2794
- Electronic flow switch. Auto-setting according to cooler size and fluid type.
- Self-regulating control
  - The control algorithm prevents excessive compressor cycling and reduces the quantity of water in the water loop (Carrier patent)
  - Automatic compressor unloading in case of abnormally high condensing pressure
  - Automatic fan speed adjustment in case of coil fouling (30RB models)
  - Smooth fan start to increase unit lifetime (optionals include variable-speed fans).
- Exceptional endurance tests:
  - To design critical components and sub-assemblies to minimise the risk of failure on site, Carrier uses specialised laboratories and advanced dynamic simulation tools.
  - To ensure that the units reach customer sites in the same condition as they are when tested in the factory, Carrier tests the machine behaviour during transportation over 250 km. The road test is based on a military standard and is the equivalent to 5000 km by truck on a normal road.
  - To guarantee the coil corrosion resistance, salt spray corrosion resistance tests are performed in the group's laboratory.
  - In addition, to maintain the unit's performance throughout its operating life whilst minimising maintenance costs, end users can access the "Connected Services" remote monitoring service.

\* The availability of sizes and options depends on the country. Please contact your local commercial dealer for more information.

# AQUASNAP® - CUSTOMER BENEFITS

## Designed to support Green Building Design

A green building is a building that is environmentally sustainable and is designed, constructed and operated to minimise the total impact on the environment.

The resulting building will be economical to operate, offer increased comfort and create a healthier environment for the people who live and work there, increasing productivity.

The air conditioning system can use between 30 and 40% of the annual building energy consumption. Choosing the right air conditioning system is one of the main considerations when designing a green building. For buildings with a load that varies throughout the year, the AquaSnap® 30RB/30RQ unit offers a solution to this important challenge.

A number of green building certification programmes exist in the market and offer third-party assessment of green building measures for a wide variety of building types.

The following example looks at how Carrier's new AquaSnap® range helps customers affected by LEED® building certification.

## Energy saving certificate

The AquaSnap® 30RB/RQ unit is eligible for energy saving certificates in France (CEE) in comfort, industrial and agriculture applications:

- Floating High pressure control (by modulating the air flow through fan activation and speed)
- Floating Low pressure control
- Variable speed on asynchronous fan motor (optional)
- Variable speed on asynchronous pump motor (optional)

For more details about financial incentives in France, please refer to the "CEE product sheet".

## The AquaSnap® range and LEED® certification

The LEED® (Leadership in Energy and Environmental Design) green building certification programme is a pre-eminent programme to rate the design, construction and operation of green buildings with points assigned in seven credit categories:

- sustainable Sites (SS)
- water efficiency (WE)
- energy and atmosphere (EA)
- materials and resources (MR)
- indoor environmental quality (IEQ)
- innovation in design (ID)
- Regional Priority (RP).

There are a number of different LEED® products.

While the strategies and categories assessed remain the same, the point distribution varies to address different building types and application needs, for example according to New Construction, Schools, Core & Shell, Retail and Healthcare.

All programmes now use the same point scale:

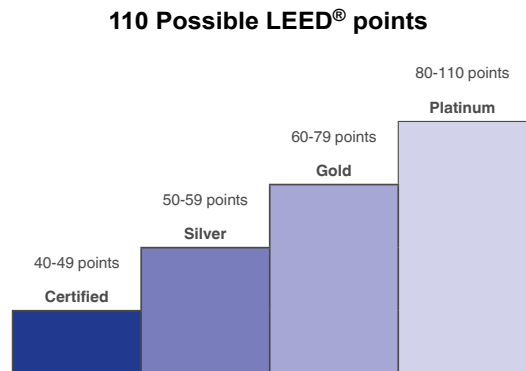

The majority of credits in LEED® rating systems are performance-based and achieving them is dependent on the impact of each component or sub-system on the building as a whole.

While the LEED® green building certification programmes do not certify products or services, choosing the right products, systems or service programmes is critical to obtain LEED® certification for a registered project, because the right products or service programmes can help meet the goals of green construction and ongoing operation and maintenance.

The choice of heating, ventilating and air conditioning (HVAC) products in particular can have a significant impact on LEED® certification, as the HVAC system directly impacts two categories that together influence 40% of the available points.

\* The availability of sizes and options depends on the country. Please contact your local commercial dealer for more information.



# AQUASNAP® - CUSTOMER BENEFITS

## Designed to support Green Building Design

### Overview of LEED® for new construction and major renovations

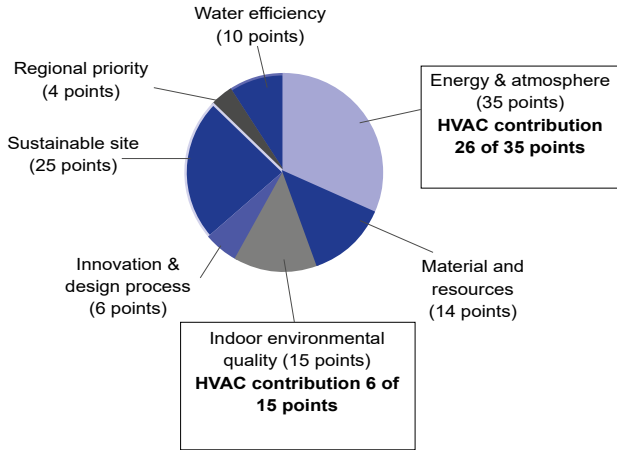

**NOTE:** This section describes the prerequisites and credit requirements in LEED® for New Construction and is directly related to the 30RB/30RQ units. Other prerequisites and credit requirements are not directly and purely related to the air-conditioning unit itself, but more to the control of the HVAC system as a whole.

i-Vu®, Carrier’s open control system, has features that can be valuable for:

- EA prerequisite 1: fundamental commissioning of energy management systems;
- EA credit 3: enhanced commissioning (2 points);
- EA credit 5: measurements and verification (3 points).

**NOTE:** Products are not reviewed or certified under LEED®. LEED® credit requirements cover the performance of materials in aggregate, not the performance of individual products or brands. For more information on LEED®, visit [www.usgbc.org](http://www.usgbc.org).

The new AquaSnap® units from Carrier can help building owners to earn LEED® points in particular in the Energy & Atmosphere (EA) credit category and help address the following prerequisites and credit requirements:

- EA prerequisite 2: Minimum energy performance
- 30RB/RQ units exceed the energy efficiency requirements of ASHRAE 90.1-2007; therefore they satisfy the prerequisites.
- EA prerequisite 3: Fundamental refrigerant management  
30RB/RQ units do not use chlorofluorocarbon (CFC) refrigerants, thus satisfying the prerequisites.
- EA credit 1: Optimise energy performance (1 to 19 points)  
Points for this credit are assigned depending on the energy cost reduction virtually achievable by the new building, compared to ASHRAE 90.1-2007 reference. 30RB/RQ units, which are designed for high performance especially during part load operation, help to reduce the building's energy consumption and therefore to gain points for this credit. In addition, the Carrier HAP (Hourly Analyses Program) can be used to analyse energy. It meets the modelling requirements for this credit and produces reports which can be easily transferred to LEED® charts.
- EA credit 4: Enhanced refrigerant management (2 points)  
With this credit, LEED® awards systems that minimise the installed system's Ozone Depletion Potential (ODP) and Global Warming Potential (GWP). 30RB/30RQ units use a reduced R-32 charge and therefore help satisfy the requirements of this LEED® credit.

\* The availability of sizes and options depends on the country. Please contact your local commercial dealer for more information.

# 30RB - 30RQ TECHNICAL OVERVIEW



## SIXTH GENERATION FLYING BIRD™ FIXED-SPEED FANS

- Exclusive Carrier design
- Fan blade design inspired by nature
- High efficiency version with AC motor technology
- Variable speed option:
  - Patented algorithm to control the fan speed.
  - Dedicated variator or EC type motor.
  - Night mode operation.

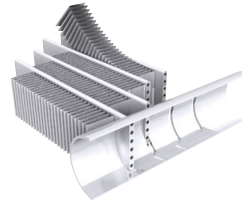

## NOVATION™ SECOND GENERATION MICRO CHANNEL HEAT EXCHANGERS (30RB)

- Increased reliability with new aluminium alloy
- Significantly reduces the refrigerant charge (-40% compared to Cu/Al coils)
- Improved thermal performance, improved efficiency and lower pressure drops compared to Cu/Al coils
- Enviro-Shield® coating for mildly corrosive environments
- Super Enviro-Shield® coating for highly corrosive environments (industrial or marine applications)
- Easy cleaning with high pressure air or water washer



## SmartVu™ control

- 6 languages available
- 4.3" user-friendly touch screen
- All main parameters displayed on one screen
- Direct access to the unit's technical drawings and the main service documents
- Very easy online monitoring
- Easy and secure access to unit parameters
- Optional Bacnet, J-Bus or LON communication interfaces



## VARIABLE-SPEED PUMP

- Water flow electronic control and reading
- Automatic protection of the pump against low pressure
- Multiple control options:
  - constant flow with low speed mode on standby
  - variable flow based on pressure difference or constant temperature

## SCROLL COMPRESSORS

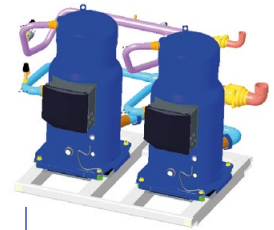

## REDUCED REFRIGERANT CHARGE



## HIGH-EFFICIENCY BRAZED PLATE HEAT EXCHANGER

- Latest generation asymmetrical type (unit with 2 circuits)
- Low pressure drop

## PUMP SPEED REGULATOR



\* The availability of sizes and options depends on the country. Please contact your local commercial dealer for more information.

## TECHNICAL INSIGHTS

### SmartVu™ control

The SmartVu™ control combines intelligence with operating simplicity. The control constantly monitors all machine parameters and precisely manages the operation of compressors, expansion devices, fans and the evaporator water pump for optimum energy efficiency.

The SmartVu™ control features advanced communication technology over Ethernet (IP) and a user-friendly and intuitive user interface with 4.3-inch colour touch screen.

- Energy management configuration
  - Internal timer: Controls chiller on/off times and operation at a second setpoint
  - Setpoint offset based on the outdoor air temperature
  - Master/slave control of two chillers operating in parallel with runtime balancing and automatic changeover in case of a unit fault.
  - For further energy savings, the AquaSnap® can be monitored remotely by Carrier experts for energy consumption diagnosis and optimisation.
- Integrated features
  - Night mode: Capacity and fan speed limitation for reduced noise level
  - With hydraulic module: Water pressure display and water flow rate calculation.
- Advanced communication features
  - Easy and high-speed communication technology over Ethernet (IP) to a centralised building management system
  - Access to multiple unit parameters.
- Maintenance functions
  - F-Gas regulation leak check reminder alert
  - Maintenance alert can be configured to days, months or hours of operation
  - Storage of maintenance manual, wiring diagram and spare parts list
  - Display of trend curves for the main values
  - Management of a fault memory allowing a log of the last 50 incidents to be accessed, with operating readings taken when the fault occurs
  - Blackbox memory

### ■ 4"3 SmartVu™ user interface



- Intuitive and user-friendly 4"3 inch touch screen interface
- Concise and clear information is available in local languages
- Complete menu, customised for different users (end user, service personnel or Carrier engineers).

### Remote management (standard)

Units with SmartVu™ control can be easily accessed from the internet, using a PC with an Ethernet connection. This makes remote control quick and easy and offers significant advantages for service operations.

The AquaSnap® is equipped with an RS485 serial port that offers multiple remote control, monitoring and diagnostic possibilities. Carrier offers a vast choice of control products, specially designed to control, manage and supervise the operation of an air conditioning system. Please consult your Carrier representative for more information.

The AquaSnap® also communicates with other centralised building management systems via optional communication gateways.

A connection terminal allows the AquaSnap® unit to be remotely controlled by wire:

- Start/stop: Opening of this contact will shut down the unit
- Dual setpoint: Closing of this contact activates a second setpoint (e.g. unoccupied mode).
- Demand limit: Closing of this contact limits the maximum chiller capacity to a predefined value.
- Operation indication: This volt-free contact indicates that the chiller is operating (cooling load).
- Alarm indication: This volt-free contact indicates the presence of a major fault that has led to the shut-down of one or several refrigerant circuits.
- Setpoint adjustable via 4-20 mA signal

\* The availability of sizes and options depends on the country. Please contact your local commercial dealer for more information.

## TECHNICAL INSIGHTS

### Novation™ heat exchangers with microchannel coil technology

Already used in the automotive and aeronautical industries for many years, the Novation™ micro-channel heat exchanger (MCHE) used in the AquaSnap® 30RB-30RBP liquid chillers is made entirely of aluminum. This one-piece concept significantly increases its corrosion resistance by eliminating the galvanic currents that are created when two different metals (copper and aluminum) come into contact in traditional heat exchangers.

- From an energy efficiency point of view, Novation™ heat exchangers are approximately 10% more efficient than traditional coils and micro-channel coil technology enables a 40% reduction in the amount of refrigerant used in the chiller.
- The reduced depth of the Novation™ MCHE reduces air pressure losses by 50% and makes it much less susceptible to fouling (e.g. by sand). The Novation™ MCHE heat exchanger can be cleaned quickly using a high-pressure washer.
- To further enhance long-term performance and protect coils against premature deterioration, Carrier offers (as options) dedicated treatments for installations in corrosive environments.
  - The Novation™ MCHE with Enviro-Shield® protection (option 262) is recommended for installations in moderately corrosive environments. The Enviro-Shield® protection uses corrosion inhibitors which actively arrest oxidation in case of mechanical damage.
  - The Novation™ MCHE with exclusive Super Enviro-Shield® protection (option 263) is recommended for installations in corrosive environments. Super Enviro-Shield® protection comprises an extremely durable and flexible epoxy coating uniformly applied over all coil surfaces for complete isolation from the contaminated environment.
- After more than 7000 hours of testing based on various standards in Carrier group laboratories, the Novation™ MCHE with Super Enviro-shield® coating emerged as the best customer choice to minimise the harmful effects of corrosive atmospheres and ensure a long equipment life:
  - best corrosion resistance per the ASTM B117/D610 test;
  - best heat transfer performance per the Carrier Marine 1 test;
  - proven reliability per the ASTM B117 test.

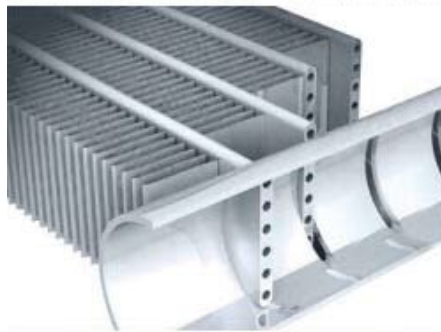

Coil Types (ranked by performance)	Visual Corrosion Evaluation	Heat Transfer Performance Degradation	Time to Failure	Test Campaign Conclusions
Super Enviro-shield® Novation™ MCHE	Very good	Good	No coil leak	Best
Super Enviro-shield® Cu/Al coil	Very good	Very good	No coil leak	Very good
Enviro-shield® Novation™ MCHE	Very good	Good	No coil leak	Very good
Al/Al coil	Very good	Good	No coil leak	Very good
Novation™ MCHE	Good	Very good	No coil leak	Good
Cu/Cu coil	Good	Good	Leak	Acceptable
Blygold® Cu/Al coil	Good	Good	No coil leak	Acceptable
Precoat Cu/Al coil	Bad	Bad	No coil leak	Bad
Cu/Al coil	Bad	Bad	No coil leak	Bad

\* The availability of sizes and options depends on the country. Please contact your local commercial dealer for more information.

## TECHNICAL INSIGHTS

---

### New generation of Flying Bird VI™ fans with AC or EC motors (optional)



The 30RB/30RQ unit uses Carrier's sixth generation Flying Bird™ fan technology, engineered for maximum efficiency, super low noise, and a wide operating range. The fans use Carrier patented rotating shroud technology and back-swept blades with a wave-serration trailing edge inspired by nature.

It was designed and optimised for the 30RB/30RQ air management system configuration and heat exchanger technology.

The fans and their impellers use Carrier's robust and proven injection moulded composite thermoplastic construction.

On the 30RB/30RQ with option 17, the fans are driven by an EC motor, also known as brushless DC, with dedicated electronics to manage commutation. This offers high precision for fans that require higher efficiency and variable speed. The fans meet the latest European Ecodesign requirements for fan efficiency.

#### EC motor (option 17)



\* The availability of sizes and options depends on the country. Please contact your local commercial dealer for more information.

## OPTIONS

Options	No.	Description	Advantages	AquaSnap 30RB- (R32)
Low-temperature brine solution	6B	Low temperature chilled water production down to -8 °C with ethylene glycol and propylene glycol.	Covers specific applications such as ice storage and industrial processes	040-160
High static fans	12	Unit equipped with high static variable-speed fans (maximum 200 Pa), each fan being equipped with a connection flange allowing the connection to the ducting system.	Ducted fan discharge, optimised temperature control, based on the operating conditions and system characteristics	040-160
Very low noise level	15LS	Acoustic compressor enclosure and low-speed fans	Noise level reduction in sensitive environments	040-160
High ambient temperature	16	Unit equipped with a higher speed fan	Unit operating range extended to higher ambient temperatures	040-160
EC fans	17	Unit equipped with EC fans	Improves the unit's energy efficiency	040-160
Protection grilles	23	Metallic protection grilles	Coil protection against possible impact	040-160
Electronic starter per compressor	25	Electronic starter on each compressor	Reduced start-up current	040-160
Winter operation down to -20 °C	28	Fan speed control via frequency converter	Stable unit operation when the air temperature is between -10 °C and -20 °C	040-160
Water exchanger frost protection	41	Electric heater on the water type heat exchanger and the water piping	Water type heat exchanger module frost protection between 0 °C and -20 °C outdoor air temperature	040-160
Hydraulic module frost protection	42	Electric heater on the hydraulic module	Hydraulic module frost protection at low outside temperatures down to -20 °C	040-160
Exchanger & hydraulic frost protection	42B	Electric heaters on the water type heat exchanger, the hydraulic module, the optional expansion vessel and the buffer tank	Water type heat exchanger and hydraulic module frost protection down to an outdoor air temperature of -20 °C	040-160
Master/slave operation	58	Unit equipped with supplementary water outlet temperature sensor kit (to be field installed) allowing master/slave operation of two units connected in parallel	Optimised operation of two units connected in parallel operation with runtime balancing	040-160
HP evap. single-pump	116R	Evaporator hydraulic module equipped with high pressure fixed-speed pump, drain valve, air vent and pressure sensors. For more details, refer to the dedicated chapter (expansion tank not included; option with built-in hydraulic safety components available.)	Quick and easy installation (plug & play)	040-160
HP dual-pump hydraulic module	116S	Dual high pressure water pump, water filter, electronic water flow rate control, pressure sensors. For more details, refer to the dedicated chapter (expansion tank not included; option with built-in hydraulic safety components available)	Quick and easy installation (plug & play)	040-160
Variable-speed single HP pump	116V	Single high pressure water pump with variable speed drive, water filter, electronic water flow control, pressure sensors. Multiple variable water flow control options. For more details, refer to the dedicated chapter (expansion tank not included; option with built-in hydraulic safety components available)	Quick and easy installation (plug & play), significant reduction in pumping energy consumption level (more than two-thirds), precise water flow control, improved system reliability	040-160
HP variable-speed dual pump	116W	Dual high-pressure water pump with variable speed drive (VSD), pressure transducers. Multiple possibilities of water flow control. For more information, refer to the dedicated chapter.	Quick and easy installation (plug & play), significant reduction in pumping energy consumption level (more than two-thirds), precise water flow control, improved system reliability	040-160
LP variable-speed single pump	116X	Variable-speed single pump. For more details, refer to the dedicated chapter (expansion tank not included)	Quick and easy installation (plug & play), significant reduction in pumping energy consumption level (more than two-thirds), precise water flow control, improved system reliability	040-160
LP variable-speed dual pump	116Y	Evaporator hydraulic module equipped with low -pressure variable-speed pump, drain valve, air vent and pressure sensors. For more details, refer to the dedicated chapter (expansion tank not included. Option with built-in safety hydraulic components available.)	Quick and easy installation (plug & play), significant reduction in pumping energy consumption level (more than two-thirds), precise water flow control, improved system reliability	040-160

\* The availability of sizes and options depends on the country. Please contact your local commercial dealer for more information.

## OPTIONS

Options	No.	Description	Advantages	AquaSnap 30RB- (R32)
LP single pump hydraulic module	116T	Single low pressure water pump, water filter, electronic water flow rate control, pressure sensors. For more details, refer to the dedicated chapter (expansion tank not included; option with built-in hydraulic safety components available)	Quick and easy installation (plug & play)	040-160
LP dual pump hydraulic module	116U	Dual low pressure water pump, water filter, electronic water flow control, pressure sensors. For more details, refer to the dedicated chapter (expansion tank not included; option with built-in hydraulic safety components available)	Quick and easy installation (plug & play)	040-160
Lon gateway	148D	Two-directional communication board complying with Lon Talk protocol	Connects the unit by communication bus to a building management system	040-160
Bacnet over IP	149	Two-directional high-speed communication using Bacnet protocol over Ethernet network (IP)	Easy and high-speed connection by Ethernet line to a BMS. Allows access to multiple unit parameters	040-160
ModBus over IP and RS485 communication gateway	149B	Bi-directional high-speed communication using the ModBus over Ethernet network (IP) protocol	Easy, quick connection via Ethernet line to a building technical management system. Allows access to several unit parameters.	040-160
Compliance with Russian regulations	199	EAC certification	Compliance with Russian regulations	040-160
Insulation of the evaporator inlet/outlet refrigerant lines	256	Thermal insulation of the evaporator inlet/outlet refrigerant lines, with flexible and UV-resistant insulation	Prevents condensation on the evaporator inlet/outlet refrigerant lines	040-160
Enviro-Shield anti-corrosion protection	262	Coating applied using a conversion process which modifies the surface of the aluminium producing a coating that is integral to the coil. Complete immersion in a bath to ensure 100% coverage. No heat transfer variation, tested to withstand more than 4000 hours of salt spray as per ASTM B117	Improved corrosion resistance, recommended for use in moderately corrosive environments	040-160
Super Enviro-Shield anti-corrosion protection	263	Extremely durable and flexible epoxy polymer coating applied on micro-channel heat exchangers by electro coating process, final UV protective topcoat. Minimal heat transfer variation, tested to withstand more than 6000 hours of constant neutral salt spray as per ASTM B117, improved impact resistance as per ASTM D2794	Improved corrosion resistance, recommended for use in extremely corrosive environments	040-160
Evaporator sleeve kit (to be screwed)	264	Evaporator inlet/outlet screw connection sleeves	Allows unit connection to a screw connector	040-160
Evaporator sleeve kit (to be welded)	266	Victaulic piping connections with welded joints	Easy installation	040-160
Reinforced ECM filtration for fan VFD	282A	Fan frequency inverter compliance with IEC 61800-3 C1 class	Allows unit installation in domestic residential environment by reducing electromagnetic interferences	040-160
Reinforced ECM filtration for pump VFD	282B	Pump frequency inverter compliance with IEC 61800-3 C1 class	Allows unit installation in domestic residential environment by reducing electromagnetic interferences	040-160
Expansion tank	293	6 bar expansion tank integrated in the hydraulic module (requires hydraulic module option)	Easy and fast installation (plug & play), & protection of closed water systems from excessive pressure	040-160
Water buffer tank module	307	Built-in water buffer tank module	Avoids short cycle on compressors and ensures stable water in the loop	040-160
Free Cooling dry cooler management	313	Control & connections to a Free Cooling Drycooler 09PE or 09VE fitted with FC control box option	Easy system management, control capabilities extended to a drycooler used in Free Cooling mode	040-160
Installation or application process outside Europe	326	Specific management of option compatibility	Permits non-standard option compatibility for HVAC application in the EU	040-160
Compliance with Moroccan regulations	327	Specific regulatory documentation	Compliance with Moroccan regulations	040-160
Plastic tarp	331	Plastic tarp covering the unit with straps and held down on a wooden pallet.	Prevents dust and external soiling on the machine during storage and transportation.	040-160

\* The availability of sizes and options depends on the country. Please contact your local commercial dealer for more information.

## PART-LOAD PERFORMANCE

With the rapid increase in energy costs and awareness of the environmental impact of electricity production, the power consumption of air conditioning equipment has become an increasingly important topic. The energy efficiency of the unit at full load is rarely representative of the actual performance of the unit, as on average a chiller works less than 5% of the time at full load.

### IPLV (in accordance with AHRI 550/590).

The **IPLV** (integrated part load value) is used to evaluate the average energy efficiency using four operating conditions defined by the AHRI (Air Conditioning, Heating and Refrigeration Institute). The **IPLV** is the average of the cooling coefficient of performance (**COP<sub>R</sub>**) under the different operating conditions, weighted by the operating time.

### IPLV (Integrated Part Load Value)

Load %	Air temperature°C	Energy efficiency	Operating time %
100	35	COP <sub>R1</sub>	1
75	26,7	COP <sub>R2</sub>	42
50	18,3	COP <sub>R</sub>	45
25	12,8	COP <sub>R4</sub>	12

IPLV = COP<sub>R1</sub> X 1% + COP<sub>R2</sub> X 42% + COP<sub>R3</sub> X 45% + COP<sub>R4</sub> X 12%

### SEER for comfort chillers (in accordance with EU ECODESIGN)

The **SEER** (Seasonal Energy Efficiency Ratio) enables the average energy efficiency of comfort chillers to be evaluated based on multiple operating conditions (load variation from 0% to 100%). From 1st January 2018, (Tier 1) and from 1st January 2021 (Tier 2), European member states will impose minimum SEER values to meet the requirements of the Ecodesign directive for ENER Lot 21 comfort cooling chillers. The Ecodesign directive aims at minimising the environmental impact of energy-related products under consideration of their full lifecycle.



**SEER is the metric for chillers used in comfort cooling applications.**

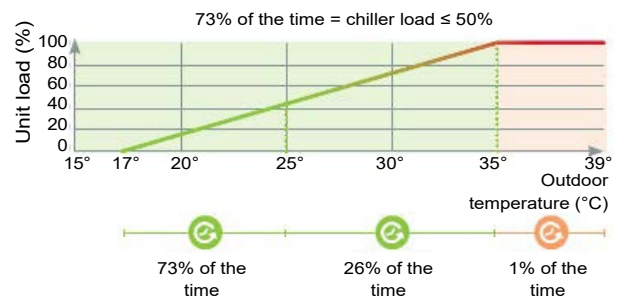

EU ECODESIGN MEPS(*) for chillers with air cooled condenser		Level 1 (from 01/01/2018)	Level 2 (from 01/01/2021)
SEER for comfort Chillers < 400kW	kWh/kWh	3,80	4,09
SEER for comfort Chillers > 400kW	kWh/kWh	4,09	4,55

(\*) Minimum energy performance standards set by EU member states to comply with the EU Ecodesign directive.

\* The availability of sizes and options depends on the country. Please contact your local commercial dealer for more information.



# PART-LOAD PERFORMANCE

## SEPR for process chillers (in accordance with the EU ECODESIGN directive)

The SEPR (Seasonal Energy Performance Ratio) enables the average energy efficiency of industrial process chillers to be evaluated based on multiple operating conditions (load variation from 80% to 100%). From 1st January 2018 (Tier 1) and from 1st January 2021 (Tier 2), European member states will impose minimum SEPR values for industrial chillers to meet the requirements of the Ecodesign directive for ENER Lot 1 for high temperature process chillers (7 °C to 12 °C) and from 1st July 2018, for ENER Lot 1 for low temperature process chillers (-25 °C to -8 °C) and medium temperature process chillers (-8 °C to 7 °C). The Ecodesign directive aims at minimising the environmental impact of energy-related products under consideration of their full lifecycle. All industrial process chillers marked with a CE label must meet the determined SEPR (Seasonal Energy Performance Ratio) value stipulated in the EU directive.



**SEPR is the metric for chillers in industrial process cooling applications.**

75% of the time = chiller operation < 17 °C ambient temperature

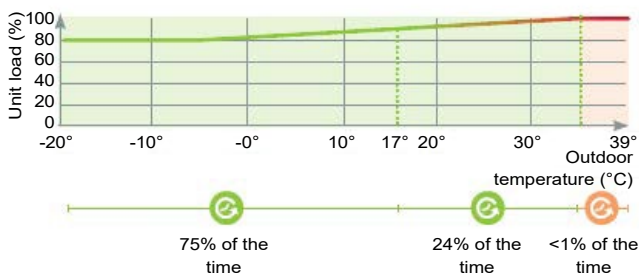

EU ECODESIGN MEPS(*) for chillers with air cooled condenser		Level 1 (from 01/07/2016)	Level 2 (from 01/07/2018)
SEPR for medium-temperature chillers kWh/kWh < 300 kW	kWh/kWh	2,24	2,58
SEPR for medium-temperature chillers kWh/kWh > 300 kW	kWh/kWh	2,80	3,22

EU ECODESIGN MEPS(*) for chillers with air cooled condenser		Level 1 (from 01/01/2018)	Level 2 (from 01/01/2021)
SEPR for high temperature process chillers kWh/kWh < 400 kW	kWh/kWh	4,50	5,00
SEPR for high temperature Process Chillers > 400 kW	kWh/kWh	5,00	5,50

(\*) Minimum Efficiency Performance Standards: Performance standards set by EU member states to meet the EU Ecodesign directive. SCOP for comfort heat pump (in accordance with the EU Ecodesign directive)

## SCOP for comfort heat pumps (in accordance with EU Ecodesign directive)

The SCOP (Seasonal Coefficient Of Performance) enables the average energy efficiency of heat pumps (< 400 kW) to be evaluated based on multiple operating conditions (load variation from 0 to 100 %). From September 2015 (Tier 1) and from September 2017 (Tier 2), European member states will impose minimum SCOP values to meet the requirements of the Ecodesign directive for ENER Lot 21 comfort chillers. The Ecodesign directive aims at minimising the environmental impact of energy-related products under consideration of their full lifecycle.

### Primary energy evaluation

In order to compare the energy efficiency of products using different energy sources, the Ecodesign directive introduced a new seasonal energy efficiency calculation known as  $\eta_s$  (Greek letter eta followed by the letter "s" for seasonal) and expressed as a percentage. For heat pumps, the SCOP (final energy) value is transposed to  $\eta_s$  (primary energy) by taking into account a conversion coefficient of 2.5 which corresponds to the average efficiency of the electrical production and various corrections for the responsiveness of the regulation system ( $i = 3$  for air-to-water heat pumps).

$$\eta_s (\%) = \frac{\text{SCOP}(\text{kW/kW}) \times 100}{2,5} - \sum_i \text{corrections}$$

The minimum seasonal efficiency requirements to be met by low temperature heat pumps, set by the standard, are as follows:



**SCOP is the metric for chillers used in heating applications**

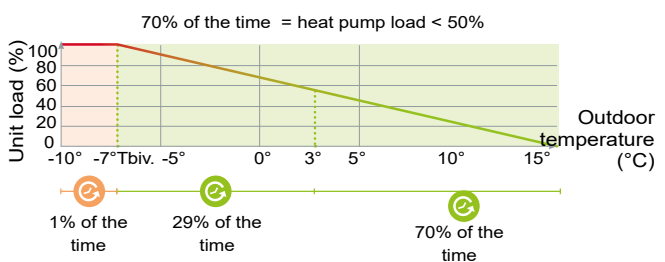

EU Ecodesign MEPS(*) for air-to-water heat pumps		Level 2 (from 09/2017)	
		Space & Hot Water 47/55 °C	Space Heating 30/35 °C
SCOP for heat pump < 400 kW	kWh/kWh	2,83	3,20
EtasS		110	125

\* The availability of sizes and options depends on the country. Please contact your local commercial dealer for more information.

# ACOUSTIC SPECTRUMS

## Minimised operating sound levels

- Standard unit features include:
  - The sixth generation of silent Flying Bird™ fans with new fan blade design inspired by nature, help reduce airflow noise.
- The AquaSnap® unit is available with 2 sound levels to match the most sensitive environments:
  - Standard: standard unit configuration with new generation low noise fans.
  - Low noise option: addition of compressor sound enclosure and fan operation at lower rotation speed.

## 30RB - Standard unit / Unit with option 16

### Sound power level (Lw)

30RB Standard unit 30RB Unit + option 16		Power level spectrum <sup>(1)</sup>								Global sound power level <sup>(2)</sup>	
		63 Hz	125 Hz	250 Hz	500 Hz	1 kHz	2 kHz	4 kHz	8 kHz		
040R	dB	75	77	79	78	78	72	66	70	dB(A)	81,5
045R	dB	75	78	79	78	79	72	65	70	dB(A)	82,0
050R	dB	74	76	78	78	81	74	66	70	dB(A)	83,5
055R	dB	74	76	78	78	81	74	66	70	dB(A)	83,5
060R	dB	75	84	84	87	85	76	71	82	dB(A)	89,0
070R	dB	78	84	84	87	85	77	71	82	dB(A)	89,0
080R	dB	80	84	84	87	84	78	74	82	dB(A)	89,0
090R	dB	80	95	90	87	89	81	74	72	dB(A)	91,5
100R	dB	82	95	90	87	88	81	74	73	dB(A)	91,5
120R	dB	82	87	87	90	87	80	77	85	dB(A)	92,0
140R	dB	81	87	87	90	88	80	74	85	dB(A)	92,0
160R	dB	83	87	87	90	87	81	77	85	dB(A)	92,0

(1) in dB ref=10<sup>-12</sup> W, as a guideline. Measured in accordance with ISO 9614-1.

(2) in dB ref=10<sup>-12</sup> W, weighting (A), with uncertainty +/-3 dB. Measured as per ISO 9614-1 and Eurovent certified.

### Sound pressure level (Lp)

Measurement conditions: Free field, 10 metres from machine, 1.5 metres above floor level, directivity 2

**Note: The sound pressure levels depend on the installation conditions of each system. As such, the levels listed here are given for information only. Only the sound power levels are comparable and certified.**

30RB Standard unit 30RB Unit + option 16		Sound pressure spectrum <sup>(1)</sup>								Global sound pressure level <sup>(2)</sup>	
		63 Hz	125 Hz	250 Hz	500 Hz	1 kHz	2 kHz	4 kHz	8 kHz		
040R	dB	44	45	48	46	47	41	34	39	dB(A)	50,0
045R	dB	44	47	48	47	48	40	34	38	dB(A)	50,5
050R	dB	43	45	47	47	50	42	34	38	dB(A)	52,0
055R	dB	43	45	47	47	50	42	34	38	dB(A)	52,0
060R	dB	43	52	53	55	54	44	40	50	dB(A)	57,5
070R	dB	46	53	53	56	53	45	40	50	dB(A)	57,5
080R	dB	49	52	53	55	53	46	43	50	dB(A)	57,5
090R	dB	49	63	59	56	57	50	42	41	dB(A)	60,0
100R	dB	50	64	59	56	57	50	42	41	dB(A)	60,0
120R	dB	51	56	56	59	56	49	45	54	dB(A)	60,5
140R	dB	49	56	56	59	56	48	43	53	dB(A)	60,5
160R	dB	52	55	56	58	56	49	46	53	dB(A)	60,5

(1) in dB ref=10<sup>-12</sup> W, as a guideline. Measured in accordance with ISO 9614-1.

(2) in dB ref=10<sup>-12</sup> W, weighting (A), with uncertainty +/-3 dB. Measured as per ISO 9614-1 and Eurovent certified.

\* The availability of sizes and options depends on the country. Please contact your local commercial dealer for more information.

## ACOUSTIC SPECTRUMS

### 30RB - Unit + option 15LS<sup>(3)</sup>

#### Sound power level (L<sub>w</sub>)

30RB Unit + option 15LS		Power level spectrum <sup>(1)</sup>								Global sound power level <sup>(2)</sup>	
		63 Hz	125 Hz	250 Hz	500 Hz	1 kHz	2 kHz	4 kHz	8 kHz		
040R	dB	74	81	78	74	75	68	61	68	dB(A)	78,5
045R	dB	75	81	77	75	76	68	62	68	dB(A)	79,0
050R	dB	72	80	76	74	78	69	61	68	dB(A)	80,0
055R	dB	72	80	76	74	78	69	61	68	dB(A)	80,0
060R	dB	72	80	77	74	78	68	62	67	dB(A)	80,0
070R	dB	75	80	76	76	77	70	62	68	dB(A)	80,0
080R	dB	77	80	78	76	77	71	64	68	dB(A)	80,0
090R	dB	77	82	81	79	80	72	65	71	dB(A)	83,0
100R	dB	79	85	82	79	80	72	65	72	dB(A)	83,0
120R	dB	79	83	81	79	79	74	67	72	dB(A)	83,0
140R	dB	78	83	79	79	80	73	65	71	dB(A)	83,0
160R	dB	80	83	81	79	80	74	67	71	dB(A)	83,0

(1) in dB ref=10<sup>-12</sup> W, as a guideline. Measured in accordance with ISO 9614-1.

(2) in dB ref=10<sup>-12</sup> W, weighting (A), with uncertainty +/-3 dB. Measured as per ISO 9614-1 and Eurovent certified.

#### Sound pressure level (L<sub>p</sub>)

Measurement conditions: Free field, 10 metres from machine, 1.5 metres above floor level, directivity 2

**Note: The sound pressure levels depend on the installation conditions of each system. As such, the levels listed here are given for information only. Only the sound power levels are comparable and certified.**

30RB Unit + option 15LS		Sound pressure spectrum <sup>(1)</sup>								Global sound pressure level <sup>(2)</sup>	
		63 Hz	125 Hz	250 Hz	500 Hz	1 kHz	2 kHz	4 kHz	8 kHz		
040R	dB	43	49	46	43	43	36	30	37	dB(A)	47,0
045R	dB	44	50	46	43	44	37	31	37	dB(A)	47,5
050R	dB	41	49	45	43	46	38	29	36	dB(A)	48,5
055R	dB	41	49	45	43	46	38	29	36	dB(A)	48,5
060R	dB	41	48	45	42	47	37	30	36	dB(A)	48,5
070R	dB	44	48	45	44	46	38	30	36	dB(A)	48,5
080R	dB	45	48	46	44	45	39	33	37	dB(A)	48,5
090R	dB	45	50	49	47	49	41	33	39	dB(A)	51,5
100R	dB	47	54	50	48	48	41	33	40	dB(A)	51,5
120R	dB	48	52	49	48	48	42	35	40	dB(A)	51,5
140R	dB	47	51	48	47	49	41	33	39	dB(A)	51,5
160R	dB	48	51	49	47	48	42	36	40	dB(A)	51,5

(1) in dB ref=10<sup>-12</sup> W, as a guideline. Measured in accordance with ISO 9614-1.

(2) in dB ref=10<sup>-12</sup> W, weighting (A), with uncertainty +/-3 dB. Measured as per ISO 9614-1 and Eurovent certified.

\* The availability of sizes and options depends on the country. Please contact your local commercial dealer for more information.

## ACOUSTIC SPECTRUMS

### 30RQ - Standard unit / Unit with option 16

#### Sound power level (Lw)-Cooling mode

30RQ Standard unit Unit + option 16		Power level spectrum <sup>(1)</sup>							Global sound power level <sup>(2)</sup>	
		63 Hz	125 Hz	250 Hz	500 Hz	1 kHz	2 kHz	4 kHz		8 kHz
040R	dB								dB(A)	
045R	dB								dB(A)	
050R	dB								dB(A)	
060R	dB								dB(A)	
070R	dB								dB(A)	
080R	dB								dB(A)	
090R	dB								dB(A)	
100R	dB								dB(A)	
120R	dB								dB(A)	
140R	dB								dB(A)	
160R	dB								dB(A)	

(1) in dB ref=10<sup>-12</sup> W, as a guideline. Measured in accordance with ISO 9614-1.

(2) in dB ref=10<sup>-12</sup> W, weighting (A), with uncertainty +/-3 dB. Measured as per ISO 9614-1 and Eurovent certified.

#### Sound pressure level (Lp)-Cooling mode

Measurement conditions: Free field, 10 metres from machine, 1.5 metres above floor level, directivity 2

**Note: The sound pressure levels depend on the installation conditions of each system. As such, the levels listed here are given for information only. Only the sound power levels are comparable and certified.**

30RQ Standard unit Unit + option 16		Sound pressure spectrum <sup>(1)</sup>							Global sound pressure level <sup>(2)</sup>	
		63 Hz	125 Hz	250 Hz	500 Hz	1 kHz	2 kHz	4 kHz		8 kHz
040R	dB									
045R	dB									
050R	dB									
060R	dB									
070R	dB									
080R	dB									
090R	dB									
100R	dB									
120R	dB									
140R	dB									
160R	dB									

(1) in dB ref=10<sup>-12</sup> W, as a guideline. Measured in accordance with ISO 9614-1.

(2) in dB ref=10<sup>-12</sup> W, weighting (A), with uncertainty +/-3 dB. Measured as per ISO 9614-1 and Eurovent certified.

\* The availability of sizes and options depends on the country. Please contact your local commercial dealer for more information.

# ACOUSTIC SPECTRUMS

## 30RQ - Unit + option 15LS

### Sound power level (L<sub>w</sub>)-Cooling mode

30RQ Unit + option 15LS		Power level spectrum <sup>(1)</sup>							Global sound power level <sup>(2)</sup>	
		63 Hz	125 Hz	250 Hz	500 Hz	1 kHz	2 kHz	4 kHz		8 kHz
040R	dB								dB(A)	
045R	dB								dB(A)	
050R	dB								dB(A)	
060R	dB								dB(A)	
070R	dB								dB(A)	
080R	dB								dB(A)	
090R	dB								dB(A)	
100R	dB								dB(A)	
120R	dB								dB(A)	
140R	dB								dB(A)	
160R	dB								dB(A)	

Awaiting data

(1) in dB ref=10<sup>-12</sup> W, as a guideline. Measured in accordance with ISO 9614-1.

(2) in dB ref=10<sup>-12</sup> W, weighting (A), with uncertainty +/-3 dB. Measured as per ISO 9614-1 and Eurovent certified.

### Sound pressure level (L<sub>p</sub>)-Cooling mode

Measurement conditions: Free field, 10 metres from machine, 1.5 metres above floor level, directivity 2

**Note: The sound pressure levels depend on the installation conditions of each system. As such, the levels listed here are given for information only. Only the sound power levels are comparable and certified.**

30RQ Unit + option 15LS		Sound pressure spectrum <sup>(1)</sup>							Global sound pressure level <sup>(2)</sup>	
		63 Hz	125 Hz	250 Hz	500 Hz	1 kHz	2 kHz	4 kHz		8 kHz
040R	dB									
045R	dB									
050R	dB									
060R	dB									
070R	dB									
080R	dB									
090R	dB									
100R	dB									
120R	dB									
140R	dB									
160R	dB									

Awaiting data

(1) in dB ref=10<sup>-12</sup> W, as a guideline. Measured in accordance with ISO 9614-1.

(2) in dB ref=10<sup>-12</sup> W, weighting (A), with uncertainty +/-3 dB. Measured as per ISO 9614-1 and Eurovent certified.

\* The availability of sizes and options depends on the country. Please contact your local commercial dealer for more information.

## UNITS WITH FANS WITH AVAILABLE HIGH PRESSURE (OPTION 12)

The design of this range using R32, is intended for outdoor installation only. Machine installation indoors is forbidden. Units with fans with available pressure are designed to be ducted to the fan discharge which results in pressure drops in the air circuit.

This option therefore features more powerful fan motors than those fitted to standard units.

For each installation, the duct pressure drops vary depending on the duct length, the duct section and the direction changes.

30RB - 30RQ units with option 12 are designed to operate with air discharge ducts with a maximum pressure drop of 200 Pa (units are equipped with variable-speed fans with a maximum speed of 19 r/s, instead of 15.8 r/s for standard units).

Use of variable speed up to 19 r/s can overcome the pressure drop in the ducts while maintaining an optimised air flow per circuit. All fans in the same circuit, operating at the same time, have the same speed.

The fan power input for fans with a speed of 19 r/s is increased compared to that of standard fans with a speed of 15.8 r/s (the multiplication coefficient is the same as the cube of the speed ratio, i.e.  $\times 1.72$ ).

The full-load or part-load speed is controlled by a patented algorithm that permanently optimises the condensing temperature to ensure the best unit energy efficiency (EER COP-SEER/SCOP) whatever the operating conditions and pressure drop of the system ductwork.

If necessary for a specific installation, the maximum fan speed of the unit can be set between 13.3 and 19 r/s, using the service configuration menu. Please refer to the control manual.

The performance levels (capacity, efficiency) depend on the speed of the fans, then on the duct pressure drop:

- Between 0 and 100 Pa, the unit performance is only slightly affected
- Between 100 and 200 Pa, the unit performance may vary considerably, depending on the operating conditions (outdoor air temperature and water conditions).

The noise level inside of the ductwork and radiated around the unit is also related to the pressure drop.

Please refer to the Carrier electronic catalogue to evaluate the estimated impact of the ducting system on the unit's operating conditions.

### Selection based on the pressure drop

The cooling capacities are given for an available pressure of 160 Pa and for a unit without filter.

To calculate the performances at other pressure drops please use the correction factors below.

#### 30RB 040R - 055R

Duct pressure drop	Fan speed, r/s	Power input coefficient	Cooling capacity coefficient
0	12,00	0,943	1,019
50	13,33	0,962	1,012
100	14,66	0,980	1,006
130	15,46	0,990	1,003
160	16,26	1,000	1,000
200	17,31	1,012	0,998
240	18,36	1,023	0,996

#### 30RB 060R - 160R

Duct pressure drop	Fan speed, r/s	Power input coefficient	Cooling capacity coefficient
0	15,83	0,929	1,018
50	16,81	0,944	1,016
100	17,78	0,964	1,014
130	18,36	0,978	1,011
160	18,36	1,000	1,000
180	18,36	1,019	0,991

#### Notes:

Pressure drop, clean filter = 6 Pa

Pressure drop, dirty filter = 12 Pa

\* The availability of sizes and options depends on the country. Please contact your local commercial dealer for more information.

## HYDRAULIC MODULE (OPTION 116)

The Carrier hydraulic module reduces the installation time. The heat pump is factory-fitted with the main components for the hydraulic system: water pump, electronic flow switch, Victaulic screen filter, pressure sensors, water temperature sensors, pressure taps (2), relief valve, drain valve, air vent, water drain, optional hydraulic module heater and optional expansion tank.

The pressure sensors enable the following operations:

- Display the available pressure at the unit outlet and the static system pressure
- Calculate the instantaneous flow rate, using an algorithm that integrates the unit characteristics
- Integrate the system and water pump protection devices (lack of water, water pressure, water flow rate, etc.).

On units fitted with a Greenspeed® variable-speed pump, the display enables users to:

- Adjust the required pump speed
- Adjust the required available pressure at the unit outlet and the static system pressure to the actual needs of the customer; this saves energy and dispenses with the need for a water flow control valve (used to create artificial pressure drops that waste energy).

Several water pump types are available to suit any application:

- Single or dual low-pressure pump or single or dual high-pressure pump
- Greenspeed variable-speed single or dual high-pressure pump.

If necessary, increased frost protection down to -20 °C is possible by adding the heater option to the hydraulic module piping (see options 42A).

The hydraulic module option is integrated into the chiller without increasing its dimensions and saves the space normally used for the water pump.

Typical hydraulic circuit diagram

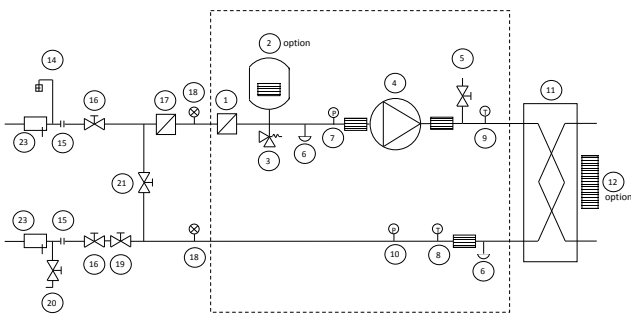

Hydraulic module



### Key

#### Components of the unit and hydraulic module:

1. Screen filter (mesh opening 1.2 mm)
2. Expansion tank (optional)
3. Relief valve
4. Available pressure pump (single pump or dual pump)
5. Air purge
6. Water drain valve
7. Pressure sensor  
**Note:** Provides suction pump pressure data
8. Temperature probe -  
**Note:** Provides heat exchanger outlet temperature data
9. Temperature probe -  
**Note:** Provides heat exchanger inlet temperature data
10. Pressure sensor  
**Note:** Provides unit outlet pressure data
11. Plate heat exchanger
12. Evaporator frost protection heater (optional)

#### Installation components

14. Air purge
15. Flexible connection
16. Shut-off valve
17. Screen filter (obligatory for a unit without hydraulic module)
18. Pressure gauge
19. Water flow control valve  
**Note:** Not necessary for a hydraulic module with a variable-speed pump
20. Charge valve
21. Frost protection bypass valve (when shut-off valves [16] are closed during winter)
23. Temperature probe well
- Hydraulic module (unit with hydraulic module)

#### Notes:

- The system must be protected against frost.
- The hydraulic module and unit evaporator are protected (option 42A, factory-installed) against frost with electric heaters (item 12 + )
- The pressure sensors are installed at connections without Schraeder valves. Depressurise and drain the system before any intervention.

## Electrical data for units with hydraulic modules

The pumps that are factory-installed in these units have motors with efficiency class IE3. Additional electrical data required by regulation No. 640/2009 can be found in the installation and maintenance manual.

This regulation concerns the application of directive 2009/125/EC on the eco-design requirements for electric motors.

\* The availability of sizes and options depends on the country. Please contact your local commercial dealer for more information.

## VARIABLE WATER FLOW (VWF)

---

### Carrier Variable Water Flow

Recommended by Carrier, the AquaSnap® can be equipped with one or two variable-speed pumps to reduce high pumping energy costs (by more than two-thirds), ensure tighter water flow rate control, and improve overall system reliability.

Carrier Variable Water Flow (VWF) is a hydraulic control function package that controls the water flow rate.

Carrier VWF not only ensures control at full load, a specific Carrier algorithm linked to an electronic frequency converter also continuously modulates the flow rate to minimise pump consumption at full load as well as part load.

The Carrier hydraulic module includes pressure sensors that permit intelligent measurement of the water flow rate and real-time display on the SmartVu™ user interface. All adjustments can be made directly on the interface, speeding up commissioning and maintenance.

As Carrier VWF acts directly on the pump, the system no longer requires the control valve at the unit outlet. However, for applications with two-way valves a bypass system must be kept to guarantee the minimum flow rate.

### Operating principle

#### ■ Full-load setpoint:

The flow rate at full load is controlled by the interface, which reduces the pump speed. This first control saves energy that would normally be dissipated in the control valve. For example, if the pressure supplied by the pump is reduced by 20% the energy consumption of the pump is reduced by the same proportion, compared to a traditional installation.



#### ■ Operating mode at part load

The controller includes three part-load operating modes:

- Fixed speed control
- Constant delta P control
- Constant delta T control.

### 1 - Fixed speed

The control continuously ensures a constant pump speed based on compressor capacity.

When the compressor capacity is equal to zero, the pump speed can be automatically reduced to a second setpoint (adjustable down to 60%) to save energy during low occupancy periods.

This solution is suitable for traditional installations with constant water flow and terminal units equipped with three-way valves. This solution reduces pumping energy costs especially when the flow can be reduced during night-time periods.

### 2 - Constant delta P control

The control continuously acts on the pump speed to ensure a constant delta P.

This solution is suitable for installations with two-way valves. When these close, the water speed will accelerate in the system branches that are still open. For a fixed-speed pump this results in an unnecessary increase of the pressure at the pump outlet.

The constant delta P control mode ensures that each circuit branch always has a uniform supply, without unnecessary energy waste.

In industrial processes such as plastic injection moulding, this solution ensures that each terminal unit has the correct pressure supply.

### 3 - Constant delta T control

The VWF algorithm maintains a constant delta T no matter what the unit load, reducing the flow rate to the minimum. It is suitable for the majority of comfort applications.

\* The availability of sizes and options depends on the country. Please contact your local commercial dealer for more information.



# PHYSICAL DATA, SIZES 040R TO 160R

30RB			040R	045R	050R	055R	060R	070R	080R	090R	100R	120R	140R	160R	
<b>Cooling</b>															
<b>Standard unit Full load performances*</b>	CA1	Nominal capacity	kW	41,8	47,3	52,9	56,1	63,6	71,2	81,2	93,4	107	124	140	160
		EER	kW/kW	2,95	2,94	2,93	2,97	2,89	2,90	2,78	2,97	2,83	2,85	2,87	2,76
	CA2	Nominal capacity	kW	54,6	62,7	69,4	74,3	84,6	93,0	103	126	142	163	183	203
		EER	kW/kW	3,60	3,61	3,51	3,61	3,63	3,49	3,22	3,72	3,48	3,40	3,48	3,21
Seasonal energy efficiency**		<b>SEER<sub>12/7°C</sub> Comfort low temp.</b>	<b>kWh/kWh</b>	<b>4,41</b>	<b>4,48</b>	<b>4,50</b>	<b>4,62</b>	<b>4,41</b>	<b>4,31</b>	<b>4,24</b>	<b>4,38</b>	<b>4,51</b>	<b>4,57</b>	<b>4,46</b>	<b>4,37</b>
		$\eta_{s\ cool\ 12/7°C}$	%	173	176	177	182	174	169	167	172	177	180	176	172
		<b>SEER<sub>23/18°C</sub> Comfort medium temp.</b>	<b>kWh/kWh</b>	<b>5,74</b>	<b>5,76</b>	<b>5,71</b>	<b>5,83</b>	<b>5,38</b>	<b>5,41</b>	<b>5,19</b>	<b>5,31</b>	<b>5,62</b>	<b>5,59</b>	<b>5,53</b>	<b>5,27</b>
		<b>SEPR<sub>12/7°C</sub> Process high temp.</b>	<b>kWh/kWh</b>	<b>6,30</b>	<b>6,23</b>	<b>6,23</b>	<b>6,21</b>	<b>5,92</b>	<b>5,46</b>	<b>5,21</b>	<b>5,45</b>	<b>5,19</b>	<b>5,25</b>	<b>5,37</b>	<b>5,15</b>
		<b>SEPR<sub>-2/-8°C</sub> Process medium temp.</b>	<b>kWh/kWh</b>	<b>3,56</b>	<b>3,64</b>	<b>3,76</b>	<b>3,87</b>	<b>3,64</b>	<b>3,60</b>	<b>3,66</b>	<b>3,53</b>	<b>3,51</b>	<b>3,72</b>	<b>3,59</b>	<b>3,66</b>
Part Load integrated values	IPLV.SI	kW/kW	4,972	5,047	5,216	5,298	5,369	4,630	4,630	4,904	4,953	4,997	4,707	4,680	
<b>Sound levels</b>															
<b>Standard unit</b>															
Sound power <sup>(1)</sup>		dB(A)	81,5	82,0	83,5	83,5	89,0	89,0	89,0	91,5	91,5	92,0	92,0	92,0	
Sound pressure at 10 m <sup>(2)</sup>		dB(A)	50,0	50,5	52,0	52,0	57,5	57,5	57,5	60,0	60,0	60,5	60,5	60,5	
<b>Unit + option 15LS</b>															
Sound power <sup>(1)</sup>		dB(A)	78,5	79,0	80,0	80,0	80,0	80,0	80,0	83,0	83,0	83,0	83,0	83,0	
Sound pressure at 10 m <sup>(2)</sup>		dB(A)	47,0	47,5	48,5	48,5	48,5	48,5	48,5	51,5	51,5	51,5	51,5	51,5	
<b>Dimensions</b>															
<b>Standard unit</b>															
Length		mm	1061	1061	1061	1061	1061	1061	1061	2258	2258	2258	2258	2258	
Width		mm	2050	2050	2050	2050	2050	2050	2050	2050	2050	2050	2050	2050	
Height		mm	1330	1330	1330	1330	1330	1330	1330	1330	1330	1330	1330	1330	
Unit height (option 12)		mm	1341	1341	1341	1341	1341	1341	1341	1341	1341	1341	1341	1341	
Unit height (option 307)		mm	1930	1930	1930	1930	1930	1930	1930	1930	1930	1930	1930	1930	
Unit height (option 12+ 307)		mm	1972	1972	1972	1972	1972	1972	1972	1972	1972	1972	1972	1972	

\* In accordance with standard EN14511-3:2018.  
 \*\* In accordance with standard EN14825:2013, average climate conditions  
 CA1 Cooling mode conditions: evaporator water inlet/outlet temperature 12 °C/7 °C, outdoor air temperature 35 °C, evaporator fouling factor 0 m<sup>2</sup>. k/W  
 CA2 Cooling mode conditions: evaporator water inlet/outlet temperature 23 °C/18 °C, outdoor air temperature 35 °C, evaporator fouling factor 0 m<sup>2</sup>. k/W  
 $\eta_{s\ cool\ 12/7°C}$  & SEER<sub>12/7°C</sub> **Values in bold comply with Ecodesign Regulation (EU) No. 2016/2281 for Comfort applications**  
 SEER<sub>23/18 °C</sub> **Values in bold comply with Ecodesign Regulation (EU) No. 2016/2281 for Comfort applications**  
 SEPR<sub>-2/-8 °C</sub> **Values in bold comply with Applicable Ecodesign regulation: (EU) No 2015/1095 for Process applications**  
 IPLV.SI Calculated as per AHRI standard 551-591.  
 (1) In dB ref=10<sup>-12</sup> W, (A) weighting. Declared dual-number noise emission value in accordance with ISO 4871 with an uncertainty of +/-3 dB(A). Measured in accordance with ISO 9614-1 and certified by Eurovent.  
 (2) In dB ref 20 µPa, (A) weighting. Declared dual-number noise emission value in accordance with ISO 4871 with an uncertainty of +/-3 dB(A). For information, calculated from the sound power level Lw(A).



Eurovent certified values

\* The availability of sizes and options depends on the country. Please contact your local commercial dealer for more information.

## PHYSICAL DATA, SIZES 040R TO 160R

30RB		040R	045R	050R	055R	060R	070R	080R	090R	100R	120R	140R	160R
<b>Operating weight<sup>(3)</sup></b>													
Standard unit	kg	404	405	424	424	430	439	447	665	725	733	848	863
Unit + high pressure single pump option	kg	425	426	444	444	450	460	467	684	745	758	874	888
Unit + high pressure dual pump option	kg	451	453	471	471	477	487	494	711	772	791	906	921
Unit + high pressure single pump and buffer tank options	kg	776	778	796	796	802	812	819	1102	1163	1176	1292	1306
Unit + high pressure dual pump and buffer tank options	kg	803	805	823	823	829	838	846	1129	1190	1209	1324	1339
<b>Compressors</b>													
Hermetic Scroll 48.3 r/s													
Circuit A		2	2	2	2	2	2	2	2	3	3	2	2
Circuit B												2	2
No. of power stages		2	2	2	2	2	2	2	2	3	3	4	4
<b>Refrigerant<sup>(3)</sup></b>													
R32 / A2L / GWP=675 following AR4													
Circuit A	kg	3,72	3,92	4,43	4,90	4,70	4,87	4,84	7,75	8,40	9,00	5,00	5,07
	teqCO <sub>2</sub>	2,5	2,6	3,0	3,3	3,2	3,3	3,3	5,2	5,7	6,1	3,4	3,4
Circuit B	kg											5,00	5,07
	teqCO <sub>2</sub>											3,4	3,4
<b>Oil</b>													
Circuit A	l	6,00	6,00	6,60	6,60	6,60	7,20	7,20	7,20	10,80	10,80	7,20	7,20
Circuit B	l											7,20	7,20
<b>Capacity control</b>													
SmartVu™													
Minimum capacity	%	50	50	50	50	50	50	50	50	33	33	25	25
<b>PED category</b>													
III													
<b>Condenser</b>													
All-aluminium micro-channel coils (MCHE)													
<b>Fans</b>													
Axial Flying Bird 6 with rotating shroud													
<b>Standard unit</b>													
Quantity		1	1	1	1	1	1	1	2	2	2	2	2
Maximum total air flow	l/s	3882	3802	4058	3900	5484	5452	5414	10568	10512	10974	10904	10827
Maximum rotation speed	r/s	12	12	12	12	18	18	18	18	18	18	18	18
<b>Evaporator</b>													
Direct expansion brazed-plate heat exchanger													
Water volume	l	3,55	4	4,44	4,44	5,18	6,07	6,96	7,4	8,44	9,92	12,69	14,31
Max. water-side operating pressure without hydraulic module	kPa	1000	1000	1000	1000	1000	1000	1000	1000	1000	1000	1000	1000
<b>Hydraulic module (optional)</b>													
Pump, Victaulic screen filter, relief valve, water and air drain valve, pressure sensors, expansion tank (optional)													
Pump		Centrifugal pump, monocoil, 48.3 r/s, low or high pressure (as required), single or dual (as required)											
Expansion tank volume	l	12	12	12	12	12	12	12	35	35	35	35	35
Max. water-side operating pressure with hydraulic module	kPa	400	400	400	400	400	400	400	400	400	400	400	400
<b>Hydraulic connections with/without hydraulic module</b>													
Victaulic® type													
Connections	inches	2	2	2	2	2	2	2	2	2	2	2	2
External diameter	mm	60,3	60,3	60,3	60,3	60,3	60,3	60,3	60,3	60,3	60,3	60,3	60,3
<b>Casing paint colour</b>													
Colour code RAL 7035													

(3) Values are guidelines only. Refer to the unit name plate.

\* The availability of sizes and options depends on the country. Please contact your local commercial dealer for more information.

# PHYSICAL DATA, SIZES 040R TO 160R

30RQ			040R	045R	050R	060R	070R	080R	090R	100R	120R	140R	160R
<b>Heating</b>													
<b>Standard unit Full load performances*</b>	HA1	Nominal capacity	kW										
		COP	kW/kW										
	HA2	Nominal capacity	kW										
		COP	kW/kW										
Seasonal energy efficiency**	HA1	SCOP <sub>30/35°C</sub>	kWh/kWh										
		ηs heat <sub>30/35°C</sub>	%										
		P <sub>rated</sub>	kW										
<b>Cooling</b>													
<b>Standard unit Full load performances*</b>	CA1	Nominal capacity	kW										
		EER	kW/kW										
Seasonal energy efficiency**		SEER <sub>12/7°C</sub> Comfort low temp.	kWh/kWh										
		SEPR <sub>12/7°C</sub> Process high temp.	kWh/kWh										
<b>Sound levels</b>													
<b>Unit + option 16</b>													
		Sound power <sup>(1)</sup>	dB(A)										
		Sound pressure at 10 m <sup>(2)</sup>	dB(A)										
<b>Standard unit</b>													
		Sound power <sup>(1)</sup>	dB(A)										
		Sound pressure at 10 m <sup>(2)</sup>	dB(A)										
<b>Unit + option 15LS<sup>(3)</sup></b>													
		Sound power <sup>(1)</sup>	dB(A)										
		Sound pressure at 10 m <sup>(2)</sup>	dB(A)										

Awaiting data

\* In accordance with standard EN14511-3:2018.  
 \*\* In accordance with standard EN14825:2013, average climate conditions  
 HA1 Heating mode conditions: Water type heat exchanger water inlet/outlet temperature 30 °C/35 °C, outdoor air temperature tdb/twb = 7 °C db/6 °C wb, evaporator fouling factor 0 m2. k/W  
 HA2 Heating mode conditions: Water type heat exchanger water inlet/outlet temperature 40 °C/45 °C, outdoor air temperature tdb/twb = 7 °C db/6 °C wb, evaporator fouling factor 0 m2. k/W  
 CA1 Cooling mode conditions: evaporator water inlet/outlet temperature 12 °C/7 °C, outdoor air temperature 35 °C, evaporator fouling factor 0 m2. k/W  
**ηs heat<sub>30/35°C</sub> & SCOP<sub>30/35°C</sub>** Values in bold comply with Ecodesign Regulation (EU) No. 813/2013 for Heating applications  
 SEER<sub>12/7 °C</sub> & SEPR<sub>12/7 °C</sub> Applicable Ecodesign regulation (EU) No. 2016/2281  
 (1) In dB ref=10<sup>-12</sup> W, (A) weighting. Declared dual-number noise emission value in accordance with ISO 4871 with an uncertainty of +/-3 dB(A). Measured in accordance with ISO 9614-1 and certified by Eurovent.  
 (2) In dB ref 20 μPa, (A) weighting. Declared dual-number noise emission value in accordance with ISO 4871 with an uncertainty of +/-3 dB(A). For information, calculated from the sound power level Lw(A).  
 (3) Options: 15LS = Very low noise level, 116W = Variable-speed high pressure dual-pump hydraulic module, 307 = Water buffer tank module,



Eurovent certified values

\* The availability of sizes and options depends on the country. Please contact your local commercial dealer for more information.

## PHYSICAL DATA, SIZES 040R TO 160R

30RQ		040R	045R	050R	060R	070R	080R	090R	100R	120R	140R	160R
<b>Dimensions</b>												
Standard unit												
Length	mm											
Width	mm											
Height	mm											
<b>Unit + option 307<sup>(3)</sup></b>												
Length	mm											
<b>Operating weight<sup>(4)</sup></b>												
Standard unit												
Unit + option xxx1 <sup>(3)</sup>	kg											
Unit + option xxx1 + option xxx2 <sup>(3)</sup>	kg											
<b>Compressors</b>												
Hermetic Scroll 48.3 r/s												
Circuit A												
Circuit B												
No. of power stages												
<b>Refrigerant<sup>(4)</sup></b>												
R32 / A2L / GWP=675 following AR4												
Circuit A												
	kg											
	tCO <sub>2</sub> e											
Circuit B												
	kg											
	tCO <sub>2</sub> e											
<b>Oil</b>												
Oil type												
Circuit A												
	l											
Circuit B												
	l											
<b>Capacity control</b>												
SmartVu™												
Minimum capacity	%											
<b>PED category</b>												
III												
<b>Condenser</b>												
Grooved copper tubes and aluminium fins												
<b>Fans</b>												
Axial with rotating impeller												
<b>Standard unit</b>												
Quantity												
Maximum total air flow	l/s											
Maximum rotation speed	r/s											
<b>Evaporator</b>												
Dual-circuit plate heat exchanger												
Water volume	l											
Max. water-side operating pressure without hydraulic module	kPa											
<b>Hydraulic module (optional)</b>												
Pump, Victaulic screen filter, relief valve, water and air drain valve, pressure sensors, expansion tank (optional)												
Pump												
Centrifugal pump, monocell, 48.3 r/s, low or high pressure (as required), single or dual (as required)												
Expansion tank volume	l											
Max. water-side operating pressure with hydraulic module	kPa											
<b>Hydraulic connections with/without hydraulic module</b>												
Victaulic® type												
Connections	inches											
External diameter	mm											
<b>Casing paint colour</b>												
Colour code RAL 7035 & 7024												

Awaiting data

(3) Options: 15LS = Very low noise level, 116W = Variable-speed high pressure dual-pump hydraulic module, 307 = Water buffer tank module,  
(4) Values are guidelines only. Refer to the unit name plate.

\* The availability of sizes and options depends on the country. Please contact your local commercial dealer for more information.

## ELECTRICAL DATA

30RB		040R	045R	050R	055R	060R	070R	080R	090R	100R	120R	140R	160R
<b>Power circuit supply</b>													
Nominal voltage	V-ph-Hz	400 - 3 -50											
Voltage range	V	360 - 440											
<b>Control circuit supply</b>		24 V via internal transformer											
<b>Maximum operating input power<sup>(1) or (2)</sup></b>													
Circuit A&B	kW	19	21	24	24	28	31	36	41	48	55	63	71
<b>Power factor at maximum power<sup>(1) or (2)</sup></b>													
Standard unit power factor		0,81	0,82	0,82	0,82	0,84	0,84	0,85	0,82	0,84	0,85	0,84	0,85
<b>Nominal unit current draw<sup>(4)</sup></b>													
Standard unit	A	26	29	35	35	36	46	52	59	71	81	91	104
<b>Maximum operating current draw (Un)<sup>(1) or (2)</sup></b>													
Standard unit	A	34	37	42	42	48	54	60	72	84	93	108	121
<b>Maximum current (Un-10%)<sup>(1) or (2)</sup></b>													
Standard unit	A	37	39	44	44	51	58	65	77	89	99	115	129
<b>Maximum start-up current (Un)<sup>(2) + (3)</sup></b>													
Standard unit	A	116	118	165	165	169	177	191	238	206	223	231	251

30RQ		040R	045R	050R	060R	070R	080R	090R	100R	120R	140R	160R	
<b>Power circuit supply</b>													
Nominal voltage	V-ph-Hz	400 - 3 -50											
Voltage range	V	360 - 440											
<b>Control circuit supply</b>		24 V via internal transformer											
<b>Maximum operating input power<sup>(1) or (2)</sup></b>													
Circuit A&B	kW												
<b>Power factor at maximum power<sup>(1) or (2)</sup></b>													
Standard unit power factor													
Unit power factor + Power factor correction option													
<b>Nominal unit current draw<sup>(4)</sup></b>													
Standard unit													
Unit + Power factor correction option	A												
<b>Maximum operating current draw (Un)<sup>(1) or (2)</sup></b>													
Standard unit													
Unit + Power factor correction option	A												
<b>Maximum current (Un-10%)<sup>(1) or (2)</sup></b>													
Standard unit													
Unit + Power factor correction option	A												
<b>Maximum start-up current (Un)<sup>(2) + (3)</sup></b>													
Standard unit	A												
Unit + Electronic starter option	A												

Awaiting data

- (1) Values at the unit's permanent maximum operating condition (as shown on the unit's nameplate).  
(2) Values at the unit's maximum operating condition (as shown on the unit's nameplate).  
(3) Maximum operating current of the smallest compressor(s) + fan current + locked rotor current of the largest compressor.  
(4) Standardised EUROVENT conditions, water-cooled exchanger inlet/outlet = 12°C/7°C, outdoor air temperature = 35°C.

\* The availability of sizes and options depends on the country. Please contact your local commercial dealer for more information.

## ELECTRICAL DATA

### Short-circuit withstand current (TN system)<sup>(1)</sup>

30RB	040R	045R	050R	055R	060R	070R	080R	090R	100R	120R	140R	160R
<b>Rated short-circuit withstand currents</b>												
Short time (1s) assigned current - I <sub>cw</sub>	kA eff	3,36	3,36	3,36	3,36	3,36	3,36	5,62	5,62	5,62	5,62	5,62
Rated peak current - I <sub>pk</sub>	kA pk	20	20	20	20	20	20	15	20	20	15	20
<b>Value with upstream electrical protection<sup>(1)</sup></b>												
Conditional short circuit assigned current I <sub>cc</sub>	kA eff	40	40	40	40	40	40	40	40	40	40	30
Associated protection - type/supplier	Circuit breaker/Schneider											
Associated protection - rating/reference	NS100H	NS100H	NS100H	NS100H	NS100H	NS100H	NS100H	NS100H	NS100H	NS160H	NS160H	NS250H

30RQ	040R	045R	050R	060R	070R	080R	090R	100R	120R	140R	160R
<b>Rated short-circuit withstand currents</b>											
Short time (1s) assigned current - I <sub>cw</sub>	kA eff	3,36	3,36	3,36	3,36	3,36	3,36	5,62	5,62	5,62	5,62
Rated peak current - I <sub>pk</sub>	kA pk	20	20	20	20	20	20	15	20	20	15
<b>Value with upstream electrical protection<sup>(1)</sup></b>											
Conditional short circuit assigned current I <sub>cc</sub>	kA eff	40	40	40	40	40	40	40	40	40	30
Associated protection - type/supplier	Circuit breaker/Schneider										
Associated protection - rating/reference	NS100H	NS100H	NS100H	NS100H	NS100H	NS100H	NS100H	NS100H	NS100H	NS160H	NS160H

(1) If another current limitation protection device is used, its time-current and thermal constraint (I<sup>2t</sup>) trip characteristics must be at least equivalent to those of the recommended protection.

Note: The short circuit current withstand capability values above are suitable with the TN system.

\* The availability of sizes and options depends on the country. Please contact your local commercial dealer for more information.

## ELECTRICAL DATA

- AquaSnap 30RB/30RQ units have a single power connection point located immediately upstream of the main switch.
  - **Control box includes:**
    - Main disconnect switch,
    - Start-up and motor protection devices for each compressor, fans and pumps,
    - Control devices.
  - **Field connections:**  
All connections to the system and the electrical installations must be in accordance with all applicable codes.
  - The Carrier AquaSnap 30RB/30RQ are designed and built to ensure conformance with these codes. The recommendations of European standard EN 60204-1 (corresponding to IEC 60204-1) (Machine safety - Electrical machine components - part 1: General regulations) are specifically taken into account, when designing the electrical equipment.
- Notes**
- Generally the recommendations of IEC 60364 are accepted as compliance with the requirements of the installation regulation.
  - Conformance with EN 60204-1 is the best means of ensuring compliance (§1.5.1) with the Machinery Directive.
  - Annex B of standard EN 60204-1 specifies the electrical features used for the operation of the units.
  - Operating conditions of AquaSnap 30RB/30RQ units are described below:
    1. Environment\*
      - The classification of environment is specified in standard EN 60364:
      - Outdoor installation\*,
      - Ambient temperature range: Minimum temperature -20 °C to +46 °C,
      - Altitude: AC1 of 2000 m or less (for the hydraulic module, see the paragraph "Electrical data for the hydraulic module"),
      - Presence of solid foreign bodies: Class AE3 (no significant dust present)\*,
      - Presence of corrosive and polluting substances, class AF1 (negligible),
      - Competence of personnel: BA4 (trained personnel).
    2. Compatibility for low-frequency conducted disturbances according to class 2 levels as per the IEC61000-2-4 standard:
      - Power supply frequency variation: +- 2Hz
      - Phase imbalance : 2%
      - Total Voltage Harmonic Distortion (THDV): 8%
- 3. The neutral (N) line must not be connected directly to the unit (if necessary use a transformer).
  - 4. Overcurrent protection of the power supply conductors is not provided with the unit.
  - 5. The factory installed disconnect switch(es)/circuit breaker(s) is (are) of a type suitable for power interruption in accordance with EN 60947-3 (corresponds to IEC 60947-3).
  - 6. The units are designed for connection to TN networks (IEC 60364). In IT networks, if noise filters are integrated into the variable frequency drive(s), this will render the machines unsuitable for their intended purpose. In addition, the short-circuit holding current characteristics are modified. Provide a local earth, consult competent local organisations to complete the electrical installation.  
AquaSnap 30RB/30RQ machines are designed for use in domestic / residential and industrial environments: Machines that are not equipped with variable-speed drives or options 282A/B comply with general standards:
    - 61000-6-3: General standards - Standard emission for residential, commercial and light industry environments
    - 61000-6-2: General standards - Immunity for industrial environments  
Machines fitted with one or more variable frequency drives (options: 6B, 28,12, 16,15LS) comply with standard:
    - 61000-6-4: Emission standard for industrial environments
    - 61000-6-2: General standards - Immunity for industrial environments
  - Leakage currents: If protection by monitoring the leakage currents is necessary to ensure the safety of the installation, the presence of a circuit with a DC component as well as additional leakage currents introduced by the use of variable frequency drive(s) in the unit must be considered (options: 6B, 28,12, 16,15LS).  
In particular, these protections must:
    - Be able to protect circuits with AC and DC components.=
    - Have a reinforced immunity protection type and a threshold no lower than 150 mA
- Note: If particular aspects of an actual installation do not conform to the conditions described above, or if there are other conditions which should be considered, always contact your local Carrier representative.**
- \* The required protection level for this class is IP43BW (according to reference document IEC 60529). All AquaSnap 30RB/30RQ units are class IP44CW and fulfil this protection condition.

\* The availability of sizes and options depends on the country. Please contact your local commercial dealer for more information.

## OPERATING LIMITS

### Evaporator water flow rate

#### 30RB 040R-160R without hydraulic module

30RB	Flow rate (l/s)		
	Minimum	Maximum <sup>(1)</sup>	Dual-pump <sup>(2)</sup> High pressure <sup>(3)</sup>
040R	0,9	3	3,4
045R	0,9	3,4	3,8
050R	0,9	3,7	4
055R	0,9	3,7	4
060R	0,9	4,2	4,4
070R	1	5	5
080R	1,2	5,5	5,2
090R	1,3	6,8	6,2
100R	1,5	7,7	6,5
120R	1,7	8,5	8
140R	2	10,6	8,7
160R	2,3	11,2	8,9

(1) Minimum flow rate for the maximum permitted water temperature difference conditions (10 K) at the minimum water outlet temperature value (5°C)

(2) Maximum flow rate for a pressure drop of 100 kPa in the plate heat exchanger

30RQ	Minimum flow rate <sup>(1)</sup> (l/s)		Maximum flow rate (l/s)	
	Single	Dual	Single	Dual
040R				
045R				
050R				
055R				
060R				
070R				
080R				
090R				
100R				
120R				
140R				
160R				

**Awaiting data**

(1) Minimum factory flow rate setting according to the type of pump

\* The availability of sizes and options depends on the country. Please contact your local commercial dealer for more information.



# OPERATING LIMITS

## Unit operating limits

### 30RB 040R-160R units

Water type heat exchanger		Minimum	Maximum
Water inlet temperature at start-up	°C	7.5 <sup>(1)</sup>	30
Water outlet temperature during operation	°C	5 <sup>(2)</sup>	20 <sup>(3)</sup>
Water outlet temperature during operation (with option 6B)	°C	-8 <sup>(2)</sup>	20 <sup>(3)</sup>
Entering/leaving water temperature difference	K	3	10
Air-cooled exchanger		Minimum	Maximum
Air inlet temperature <sup>(3)</sup> (30RB)	°C	-10	48 <sup>(5)</sup>
Air inlet temperature (30RB option 6B, 12, 15LS, 28)	°C	-20	48 <sup>(5)</sup>
Air inlet temperature (30RB option 16)	°C	-20	52 <sup>(6)</sup>
Available static pressure (option 12)			
30RB standard	Pa	0	
30RB + option 12 (high-pressure static fans)	Pa	200	
Hydraulic module <sup>(6)</sup>			
Air inlet temperature			
Kit without pump	°C	-20	-
Kit with pump (option 116x)	°C	-10	-
Kit with pump (option 116x) and frost protection option to -20 °C (option 42)	°C	-20	-
Kit with buffer tank (option 307)	°C	0	-
Kit with buffer tank (option 307) and frost protection to -20 °C (option 42B)	°C	-20	-

- (1) For an application requiring start-up at less than 8°C, contact Carrier to select a unit using the Carrier electronic catalogue.
- (2) The use of antifreeze is obligatory if the water outlet temperature is below 5 °C.
- (3) For applications requiring operation above a water outlet temperature of 20 °C, contact Carrier to select a unit using the Carrier electronic catalogue.
- (4) For operation at an ambient temperature below 0 °C, the unit must be equipped with the water type heat exchanger frost protection option (for units without hydraulic module option) or the water type heat exchanger and hydraulic module frost protection option (for units with hydraulic module option) or the water loop must be protected against frost by the installer, using an antifreeze solution.
- (5) Part load operation permitted above an outdoor temperature of 48 °C. Contact Carrier to select a unit using the electronic Carrier catalogue.

**Ambient temperatures during shutdown: The storage and transportation of 30RB units must be carried out at ambient temperatures between -20 °C and +51 °C. These temperature limits shall be considered in case of container shipment.**

### Operating range 30RB 040R-160R standard unit

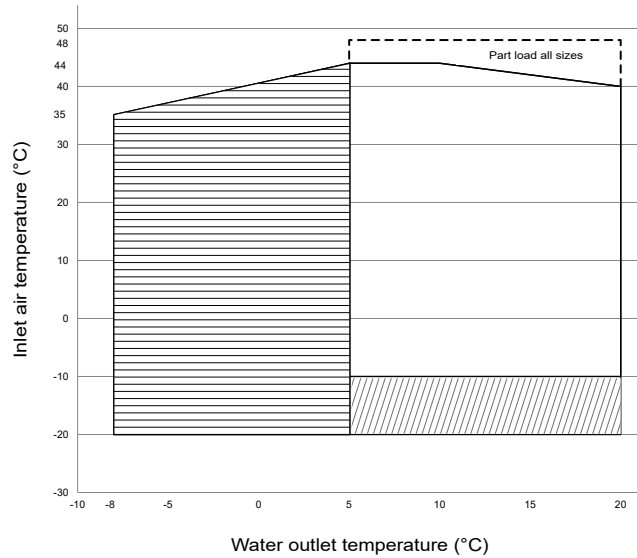

### Operating range 16 30RB 040R-160R optional unit

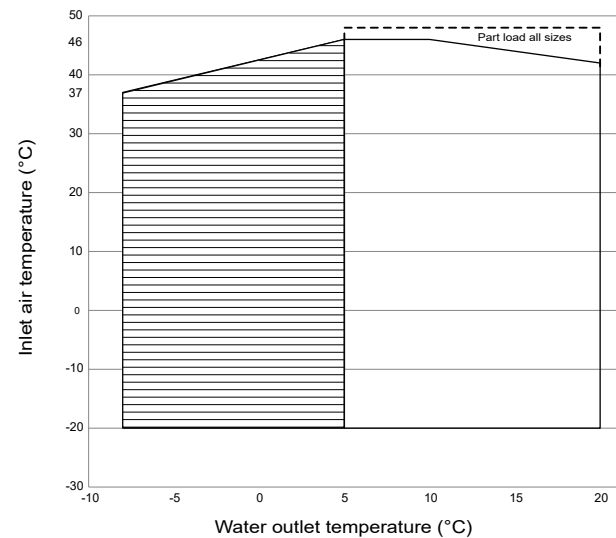

#### Notes:

1. Water type heat exchanger  $\Delta T = 5K$ .
2. The hydraulic module and/or water type heat exchanger must be protected against frost (option 41 or 42A or 42B) or the loop must be protected by an antifreeze solution for outdoor temperatures < 0 °C.
3. Operating ranges are guidelines only. Verify the operating range with the electronic catalogue.

#### Key:

- Operating range at full load
- Extension of the operating range 30RB unit option 6B, 28, 12, 17, 15LS:
- Frost protection required (see note 2).
- Operating range of units at part load.
- Extension of the operating range 30RB unit option 6B, (See note 2).

\* The availability of sizes and options depends on the country. Please contact your local commercial dealer for more information.

# AVAILABLE STATIC SYSTEM PRESSURE

Data applicable for:

- Pure water at 20 °C.
- Refer to the section “Evaporator flow rate” for the maximum water flow values.
- If glycol is used, the maximum water flow is reduced.

## 30RB 040R-160R units

### High-pressure pumps (fixed speed or variable speed)

#### Single pumps

#### Sizes 040R- 080R

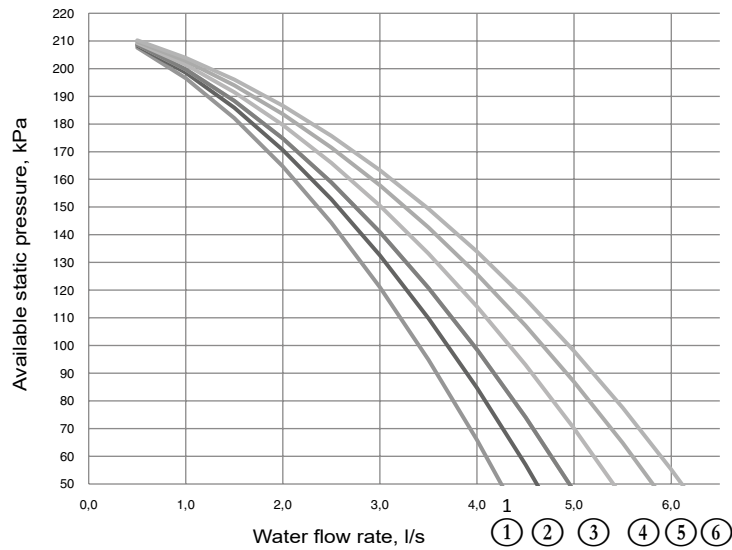

- 1 30RB - 040R
- 2 30RB - 045R
- 3 30RB - 050R - 55R
- 4 30RB - 060R
- 5 30RB - 070R
- 6 30RB - 080R

#### Sizes 090R-160R

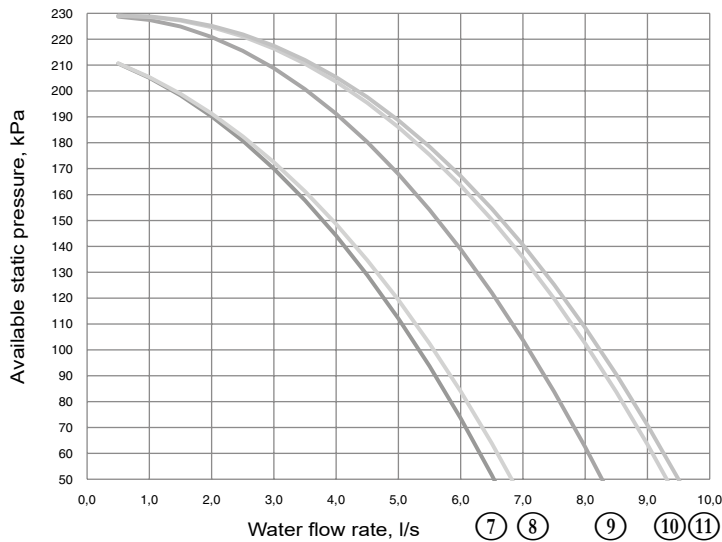

- 7 30RB - 090R
- 8 30RB - 100R
- 9 30RB - 120R
- 10 30RB - 140R
- 11 30RB - 160R

\* The availability of sizes and options depends on the country. Please contact your local commercial dealer for more information.

# AVAILABLE STATIC SYSTEM PRESSURE

## Dual pumps

### Sizes 040R-080R

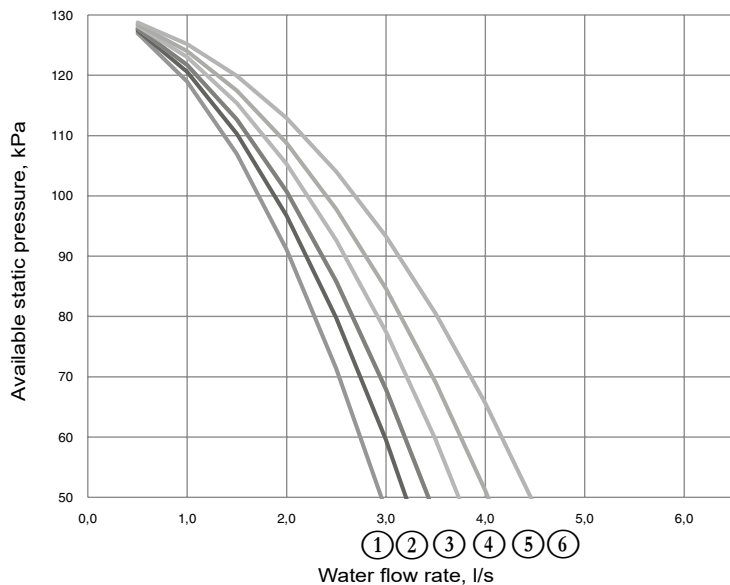

- 1 30RB - 040R
- 2 30RB - 045R
- 3 30RB - 050R - 55R
- 4 30RB - 060R
- 5 30RB - 070R
- 6 30RB - 080R

### Sizes 090R-160R

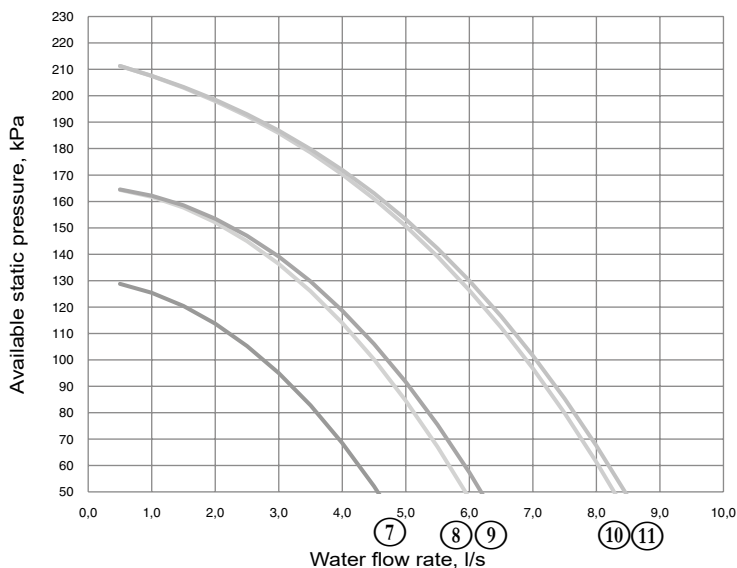

- 7 30RB - 090R
- 8 30RB - 100R
- 9 30RB - 120R
- 10 30RB - 140R
- 11 30RB - 160R

- 10 30RB-RBP 610R - 720R
- 11 30RB-RBP 770R - 950R

\* The availability of sizes and options depends on the country. Please contact your local commercial dealer for more information.

## DIMENSIONS/CLEARANCES

### 30RB/30RQ 040R-080R, units with and without hydraulic module

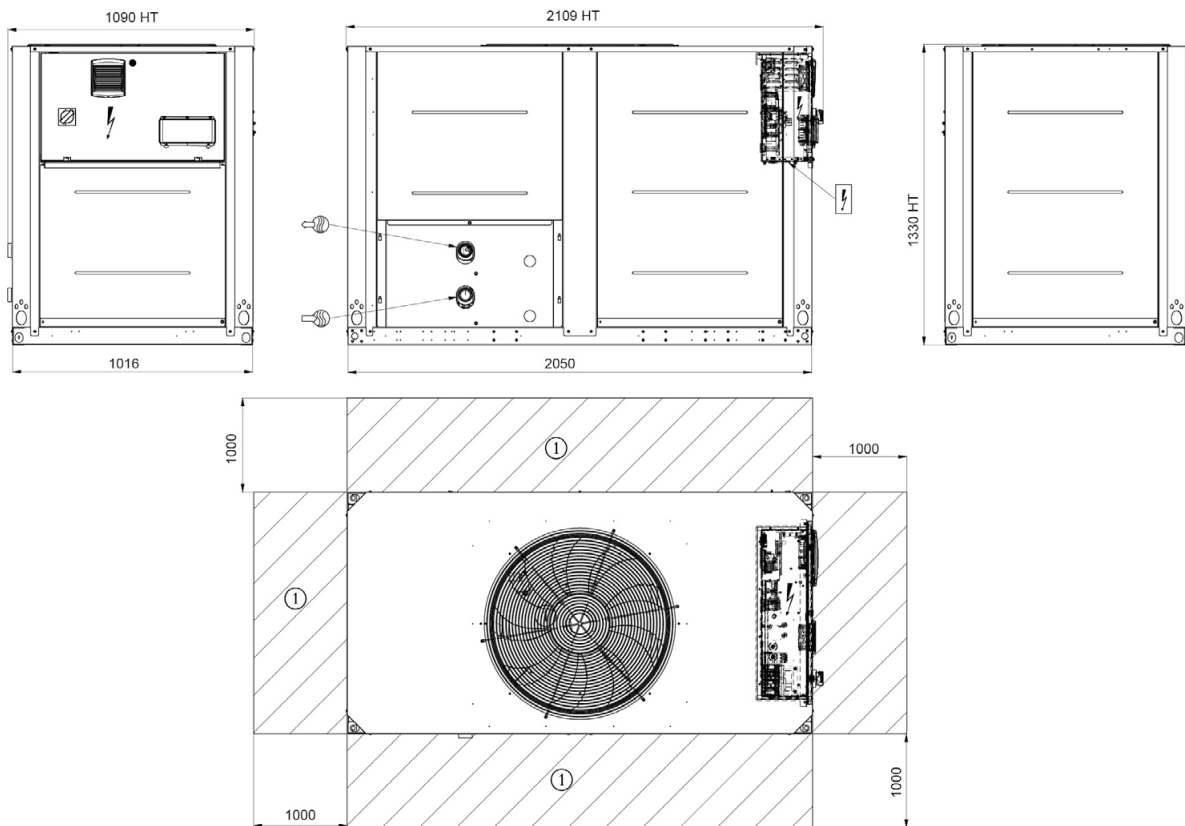

#### Key:

All dimensions are given in mm.

- ① Clearances required for maintenance and air flow
- ② Clearance recommended for coil removal
- ⊕ Water inlet
- ←⊕ Water outlet
- ⋈ Air outlet, do not obstruct
- ⚡ Control box

#### NOTE: Non-contractual drawings.

When designing a system, refer to the certified dimensional drawings provided with the unit or available on request.

Refer to the certified dimensional drawings for the location of fixing points, weight distribution and coordinates of the centre of gravity, hydraulic and electrical connections.

\* The availability of sizes and options depends on the country. Please contact your local commercial dealer for more information.

# DIMENSIONS/CLEARANCES

## 30RB/30RQ 090R-160R, units with and without hydraulic module

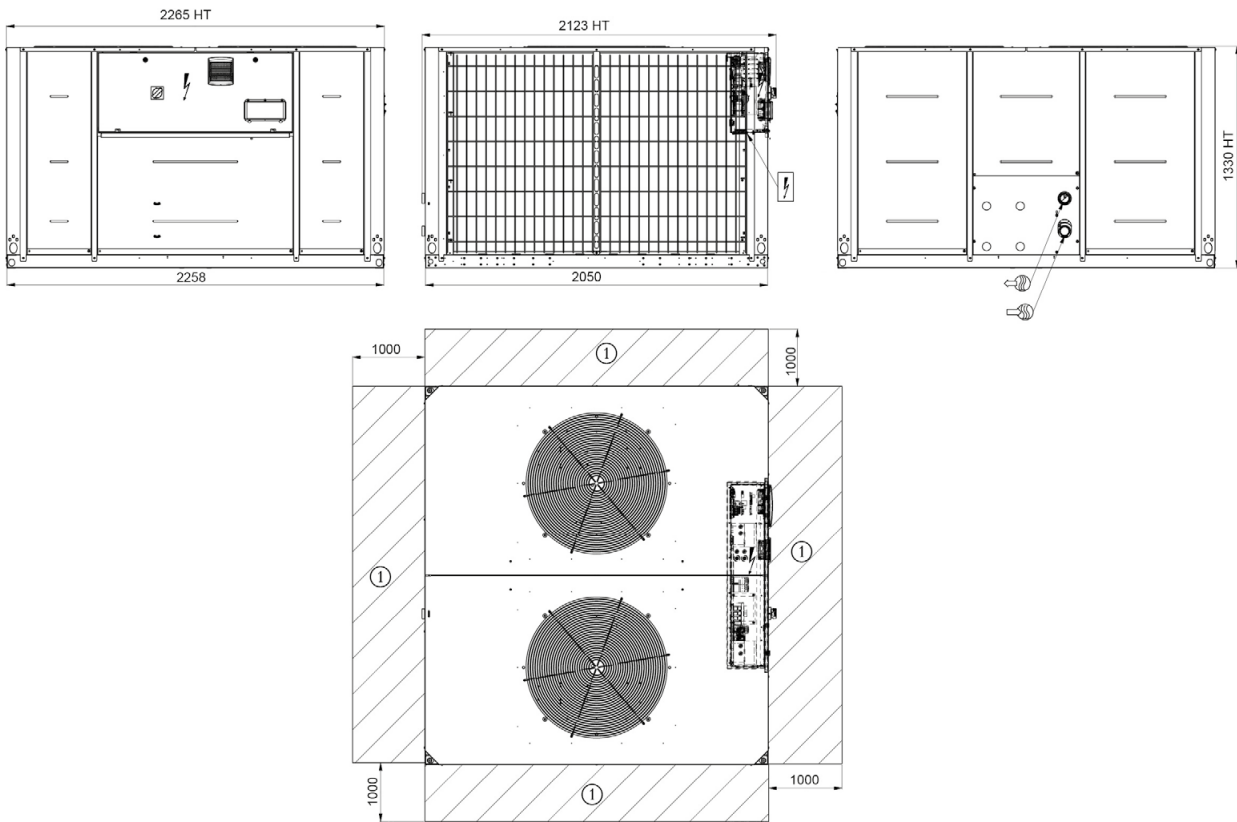

**Key:**

All dimensions are given in mm.

- ① Clearances required for maintenance and air flow
- ② Clearance recommended for coil removal
- ⊕ Water inlet
- ⊖ Water outlet
- ⋈ Air outlet, do not obstruct
- ⚡ Control box

**NOTE: Non-contractual drawings.**

**When designing a system, refer to the certified dimensional drawings provided with the unit or available on request.**

**Refer to the certified dimensional drawings for the location of fixing points, weight distribution and coordinates of the centre of gravity, hydraulic and electrical connections.**

\* The availability of sizes and options depends on the country. Please contact your local commercial dealer for more information.

## DIMENSIONS/CLEARANCES

### 30RB/30RQ 040R-080R, units with water buffer tank module

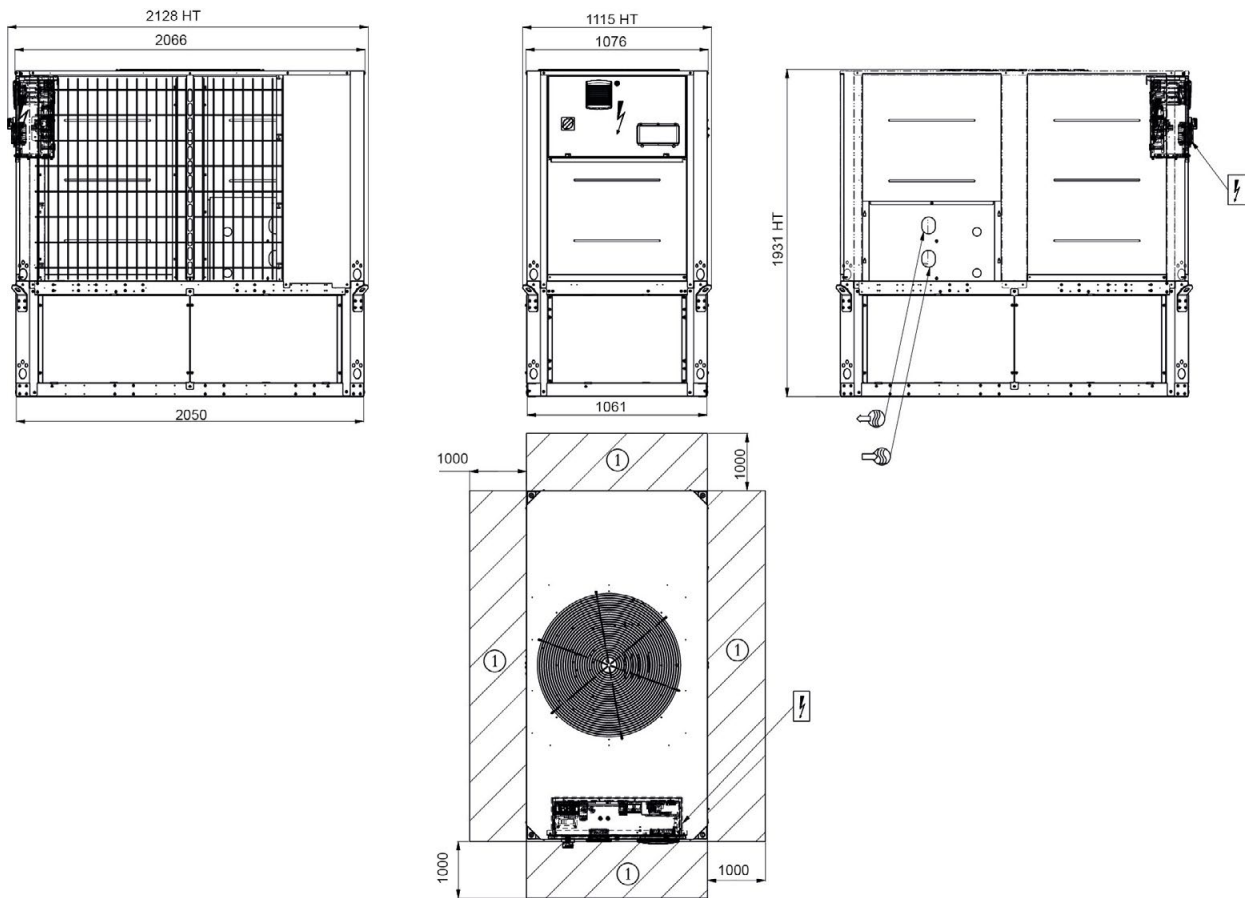

**NOTE: Non-contractual drawings.**

**When designing a system, refer to the certified dimensional drawings provided with the unit or available on request.**

**Refer to the certified dimensional drawings for the location of fixing points, weight distribution and coordinates of the centre of gravity, hydraulic and electrical connections.**

\* The availability of sizes and options depends on the country. Please contact your local commercial dealer for more information.

# DIMENSIONS/CLEARANCES

## 30RB/30RQ 090R-160R, units with water buffer tank module

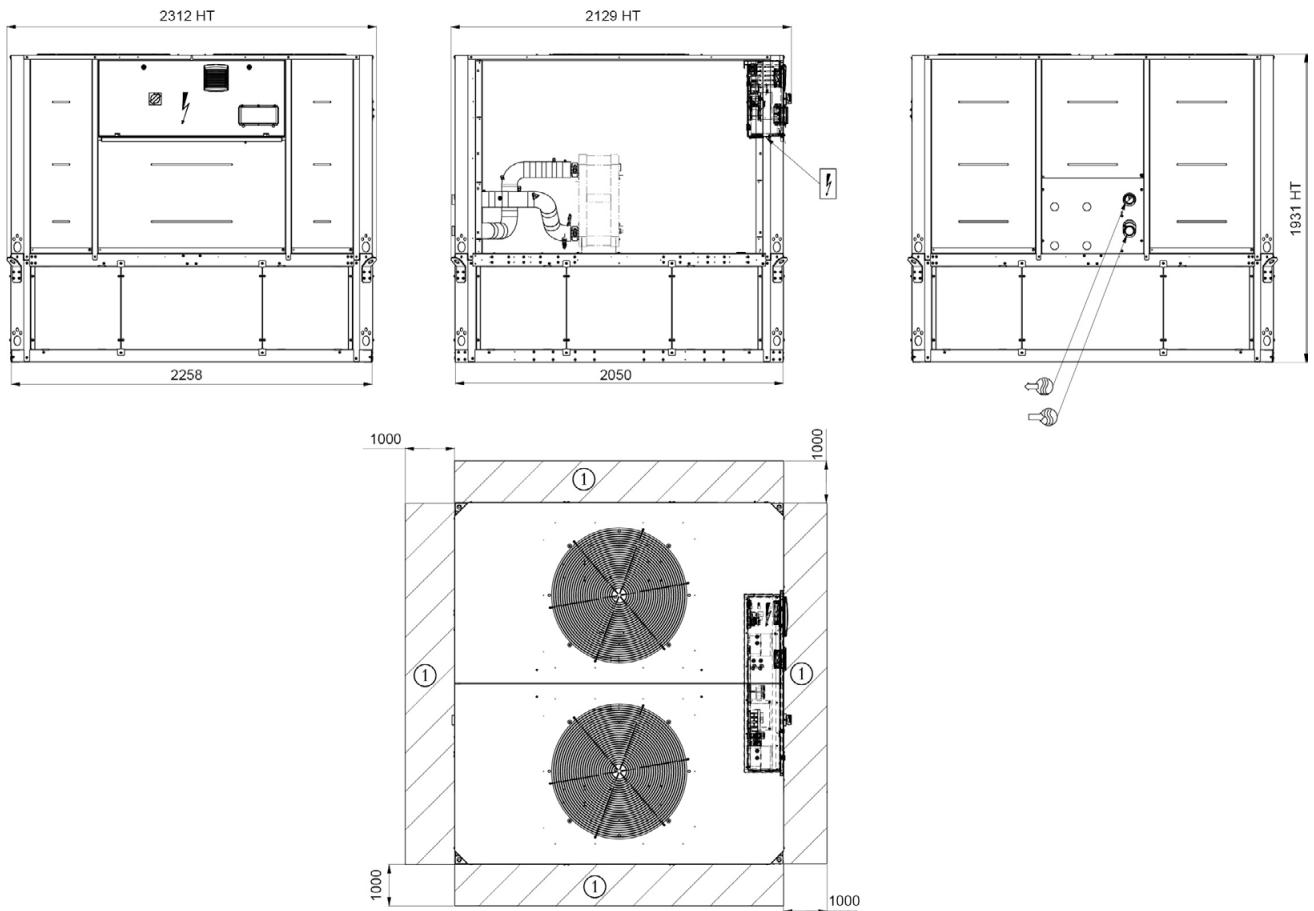

**Key:**

All dimensions are given in mm.

- ① Clearances required for maintenance and air flow
- ② Clearance recommended for coil removal
- ⊕ Water inlet
- ⊖ Water outlet
- ⋄ Air outlet, do not obstruct
- ⚡ Control box

**NOTE: Non-contractual drawings.**

**When designing a system, refer to the certified dimensional drawings provided with the unit or available on request.**

**Refer to the certified dimensional drawings for the location of fixing points, weight distribution and coordinates of the centre of gravity, hydraulic and electrical connections.**

\* The availability of sizes and options depends on the country. Please contact your local commercial dealer for more information.



Order No.: 10604, 12.2020 - Supersedes order No.: 08.2020.  
The manufacturer reserves the right to change any product specifications without notice.  
The illustrations in this document are for illustrative purposes only and not part of any offer for sale or contract.  
The manufacturer reserves the right to change the design at any time without notice.

Manufactured by: Carrier SCS, Montluel, France.